

Medication Adherence

Solutions to improve medication safety and patient compliance



Product Catalog

VOLUME 6

About Omnicell Medication Adherence

Omnicell is a trusted partner to long-term care (LTC), institutional, and hybrid pharmacies across the United States and in global markets including the UK, DACH region, Australia, and Canada. Our Medication Adherence division is dedicated to helping pharmacies improve patient outcomes through innovative packaging and automation solutions that enhance operational efficiency, medication safety, and adherence.

At the heart of the Medication Adherence business is our manufacturing facility in St. Petersburg, Florida, where we produce the wide range of high-quality blister cards, labels, and packaging components found in this catalog.

From single-dose and multimed blister cards to guided labeling software and automation platforms like E3 and Autogen, our Medication Adherence portfolio is designed to streamline workflows, reduce labor costs, and support compliance. This portfolio is part of Omnicell's broader suite of medication and medical supply management solutions across all settings of care.



Contact Information

Customer Service: +1 800-845-0053

Technical Service: +1 800-671-0587

Sales Assistance: MAInsideSales@Omnicell.com

Account #

Sales Representative

Customer Service Representative

Table of Contents

Single Dose Blister Cards.....	5	Medication Packaging Automation.....	79
Blister Sizes & Accessories.....	7	Pre-pack Automation.....	81
Heat Seal Cards.....	8	MTS-350.....	81
Cold Seal Cards.....	13	MTS-500.....	82
1-Piece Cards.....	16	Single Dose Automation.....	83
Reclaimable Select Seal Cards & Non-Reclaimable Med Cards.....	21	AccuFlex 3.....	83
Control Cards & Trap Door Cards.....	26	Express III (E3).....	84
Mealtime Cards.....	29	Automated Dispensing Cabinets.....	85
14, 15, 16-Day/Dose Cards.....	30	XT Automated Dispensing Cabinet.....	87
Opti-Pak™ System.....	33	Printing & Labeling Solutions.....	89
Unit Dose Solutions.....	35	Software Specific Labels.....	91
Unit Dose Blisters, Unit Dose Foil, & Unit Dose Boxes.....	37	Framework.....	91
Reclaimable Packaging System: Select Seal Cards.....	38	QS1.....	96
Non-Reclaimable Packaging System: Med Cards.....	40	Automation Labels.....	101
Unit Dose Foil Labeling System.....	42	DOSIS Labels.....	103
MultiMed Blister Cards.....	43	Auxiliary & Time Pass Labels.....	105
Cold Seal & Heat Seal Accessories.....	45	Pre-pack Labels.....	108
Non-Perforated Tri-Fold Cards.....	46	Popular Label Templates.....	110
Perforated Cards.....	50	Ribbon.....	119
DosiPill.....	53	Unit Dose Foil.....	120
Automation Supported Consumables.....	55	Unit Dose Printing System.....	123
Single Dose Automation Consumables.....	57	Printers.....	124
AccuFlex 3 & Express III (E3).....	57	Desktop Label Applicator (DLA).....	125
DOSIS.....	61	Miscellaneous Accessories.....	127
MultiMed Automation Consumables.....	65	Cold Seal Roller & Pil-Bob.....	129
Medication Packaging Equipment.....	69	Storage Boxes.....	130
Autogen.....	71	Placebo Pills.....	133
SureSeal.....	72	Custom Product.....	137
Deblister Machine.....	73	Custom Cards.....	139
KirbyLester (KL1).....	74	Custom Labels.....	140
Medication Packaging Software.....	75		
Guided Packing MultiMed Software.....	77		

Single Dose Blister Cards



Omnicell is the industry leader of single dose blister cards with a robust portfolio and assortment of form factors. Cards are offered in standard 30, 31, 60, 62, and 90-dose as well as in a variety of other dose forms.

Blister Sizes & Accessories

Blister Sizes Small | Medium | Large | XL

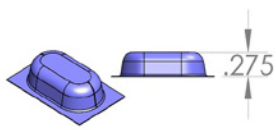

Small Blister
.275"

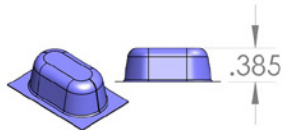

Medium Blister
.385"

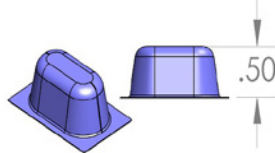

Large Blister
.50"

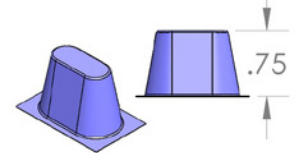

XL Blister
.75"

Heat Seal Accessories



Item 651-32
30, 31, 32-Dose 2-Up
Paddle 5/8" thick



Item 651-31
30, 31, 32-Dose 2-Up
Paddle 7/8" thick



Item 651-62
60, 62-Dose 2-Up
Paddle 5/8" thick

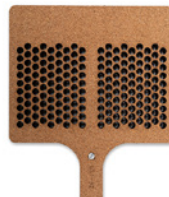

Item 651-92
90-Dose 2-Up
Paddle 5/8" thick



Item 651-94
Unit Dose 2-Up
Paddle with Pins



Item 651-37
30 Mini Control
4-Up Paddle 5/8"
thick



Item 651-36
32, 62-Dose 2-Up
Paddle 5/8" thick



Item 651-44
OptiPak Sealing
Template

Cold Seal Accessories



Item 655-30
30, 31, 32-Dose Cork



Item 655-30A
30, 31, 32-Dose Cork
for XL Blisters

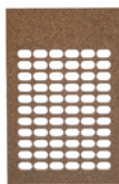

Item 655-60
60, 62-Dose Cork



Item 655-90
90-Dose Cork



Item 660-00
Cold Seal Roller

Item 300-07

30-Dose Heat Seal Card

Quantity: 500/Box

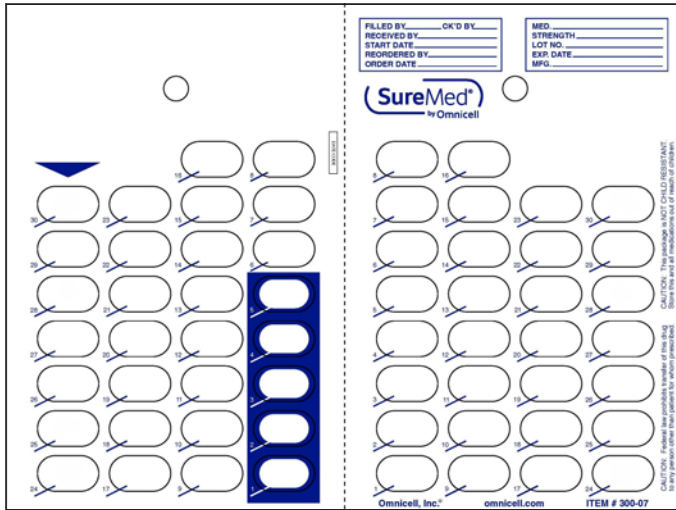

*XL blister requires deeper paddle.

Coordinating Blisters

Quantity: 1,000/Box

Item Number	Description
200-27	Small Blister
200-28	Medium Blister
200-30	Large Blister
200-51*	XL Blister
203-29	Small Amber Blister
203-32	Medium Amber Blister
203-34	Large Amber Blister

Recommended Accessories

Quantity: 1

Item Number	Description
651-32	Paddle 5/8" thick
651-31*	Paddle 7/8" thick

Refer to page 7 for blister sizes

Item 300-25

31-Dose Heat Seal Card

Quantity: 500/Box

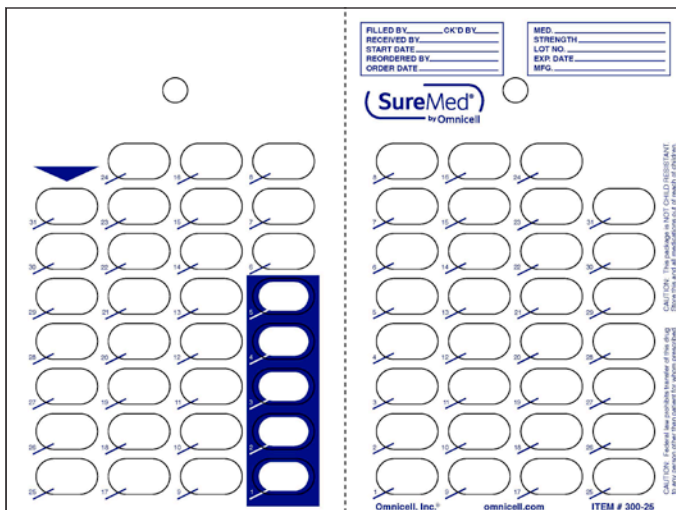

*XL blister requires deeper paddle.

Coordinating Blisters

Quantity: 1,000/Box

Item Number	Description
200-31	Small Blister
200-32	Medium Blister
200-34	Large Blister
200-52*	XL Blister
203-30	Small Amber Blister
203-31	Medium Amber Blister
203-33	Large Amber Blister

Recommended Accessories

Quantity: 1

Item Number	Description
651-32	Paddle 5/8" thick
651-31*	Paddle 7/8" thick

Refer to page 7 for blister sizes

Item 300-16

31-Dose Calendar Heat Seal Card

Quantity: 500/Box

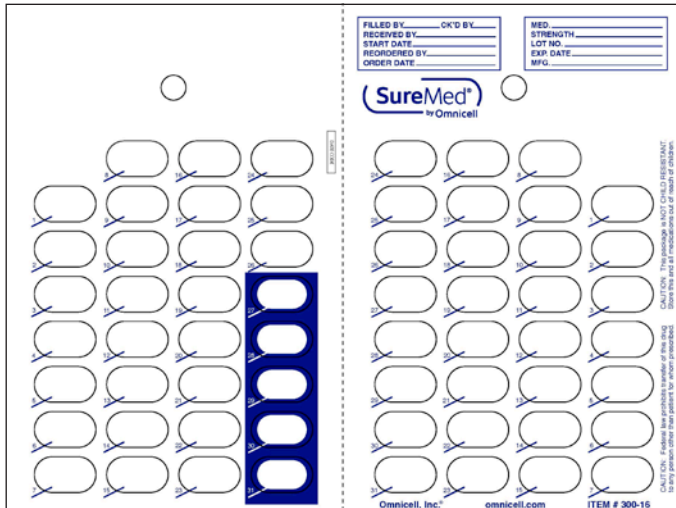

*XL blister requires deeper paddle.

Coordinating Blisters

Quantity: 1,000/Box

Item Number	Description
200-31	Small Blister
200-32	Medium Blister
200-34	Large Blister
200-52*	XL Blister
203-30	Small Amber Blister
203-31	Medium Amber Blister
203-33	Large Amber Blister

Recommended Accessories

Quantity: 1

Item Number	Description
651-32	Paddle 5/8" thick
651-31*	Paddle 7/8" thick

Refer to page 7 for blister sizes

Item 300-12

32-Dose Heat Seal Card

Quantity: 500/Box

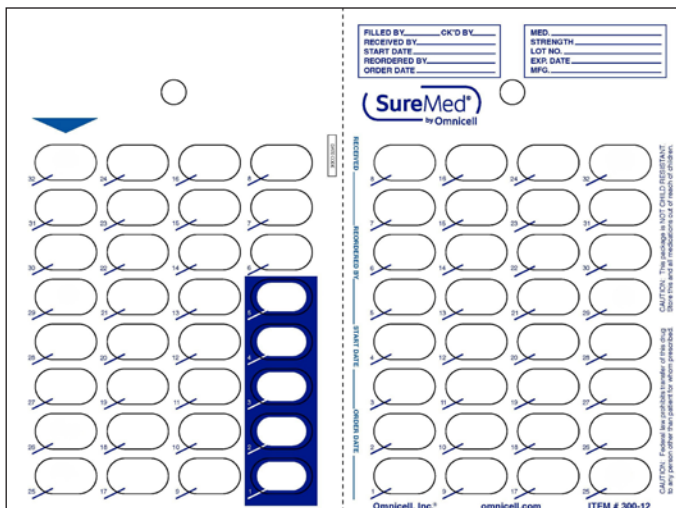

Coordinating Blisters

Quantity: 1,000/Box

Item Number	Description
200-35	Small Blister
200-36	Medium Blister
200-38	Large Blister

Recommended Accessories

Quantity: 1

Item Number	Description
651-32	Paddle 5/8" thick

Refer to page 7 for blister sizes

Item 300-38

28-Dose Heat Seal Blank Card

Quantity: 500/Box

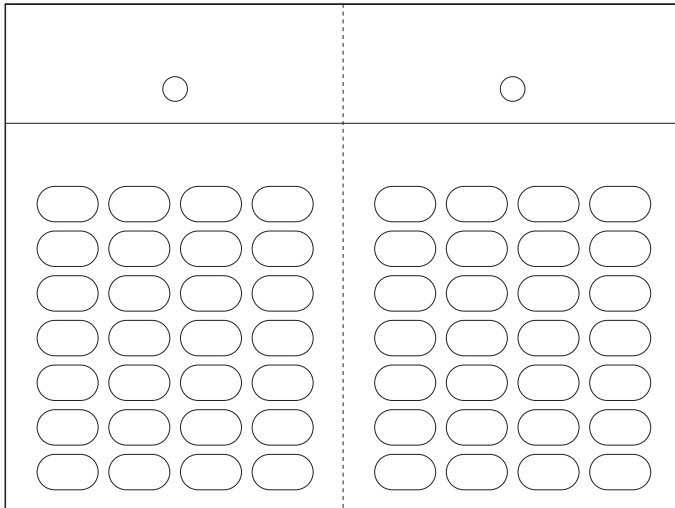

*XL blister requires deeper paddle.

Coordinating Blisters

Quantity: 1,000/Box

Item Number	Description
200-15	Small Blister
200-16	Medium Blister
200-18	Large Blister
200-50*	XL Blister
203-16	Large Amber Blister

Recommended Accessories

Quantity: 1

Item Number	Description
651-32	Paddle 5/8" thick
651-31*	Paddle 7/8" thick

Refer to page 7 for blister sizes

Item 300-28

30-Dose Heat Seal Blank Card

Quantity: 500/Box

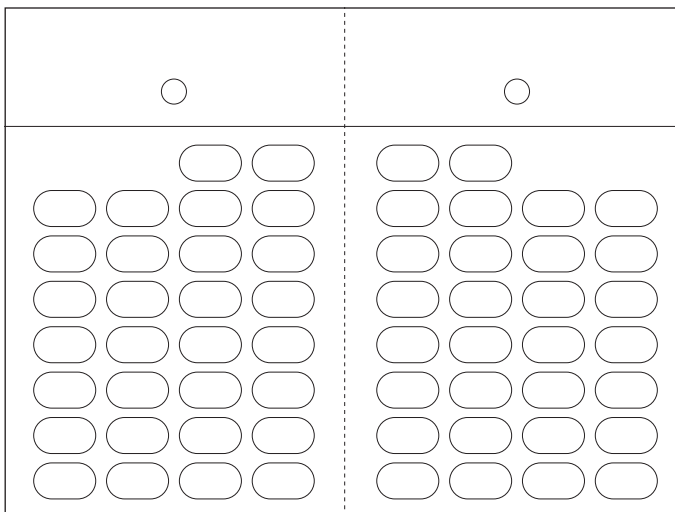

*XL blister requires deeper paddle.

Coordinating Blisters

Quantity: 1,000/Box

Item Number	Description
200-27	Small Blister
200-28	Medium Blister
200-30	Large Blister
200-51*	XL Blister
203-29	Small Amber Blister
203-32	Medium Amber Blister
203-34	Large Amber Blister

Recommended Accessories

Quantity: 1

Item Number	Description
651-32	Paddle 5/8" thick
651-31*	Paddle 7/8" thick

Refer to page 7 for blister sizes

Item 300-09

60-Dose Heat Seal Card

Quantity: 500/Box

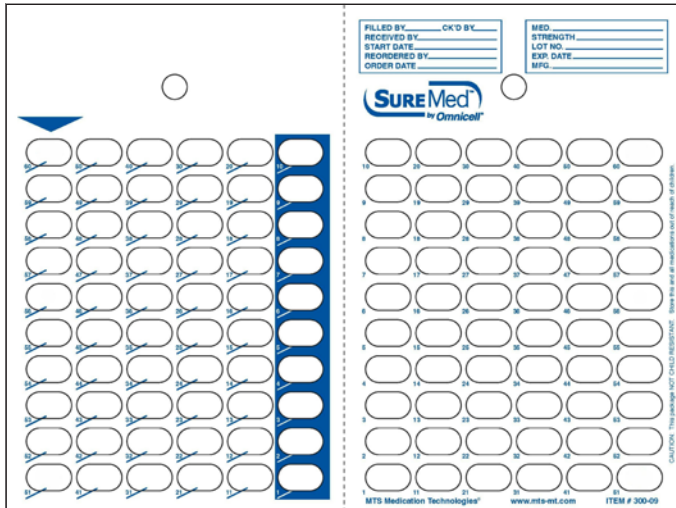

Coordinating Blisters

Quantity: 1,000/Box

Item Number	Description
200-60	Blister
203-60	Amber Blister

Recommended Accessories

Quantity: 1

Item Number	Description
651-62	60, 62 Dose Paddle 5/8" thick

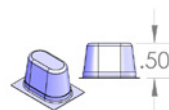

60-Dose Blister
.50"

Item 300-27

62-Dose Heat Seal Card

Quantity: 500/Box

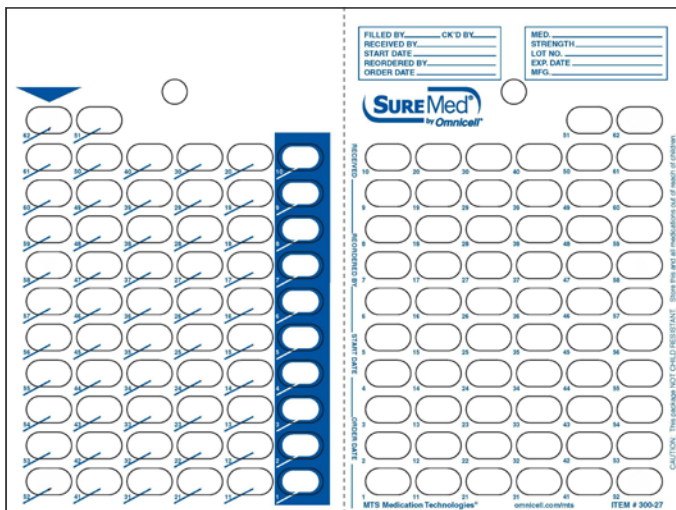

Coordinating Blisters

Quantity: 1,000/Box

Item Number	Description
200-23	Blister
200-25	Amber Blister

Recommended Accessories

Quantity: 1

Item Number	Description
651-62	60, 62-Dose Paddle 5/8" thick

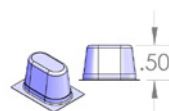

62-Dose Blister
.50"

Item 300-11

90-Dose Heat Seal Card

Quantity: 500/Box

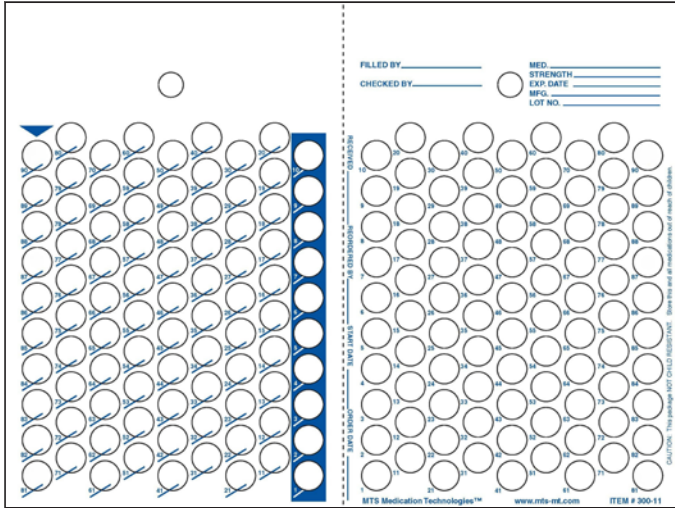

Coordinating Blisters

Quantity: 1,000/Box

Item Number	Description
-------------	-------------

200-24	Blister
203-26	Amber Blister

Recommended Accessories

Quantity: 1

Item Number	Description
-------------	-------------

651-92	90-Dose Paddle 5/8" thick
--------	---------------------------



90-Dose Blister
.335"

Item 300-39

30-Dose Cold Seal Card (Red)

Quantity: 250/Box

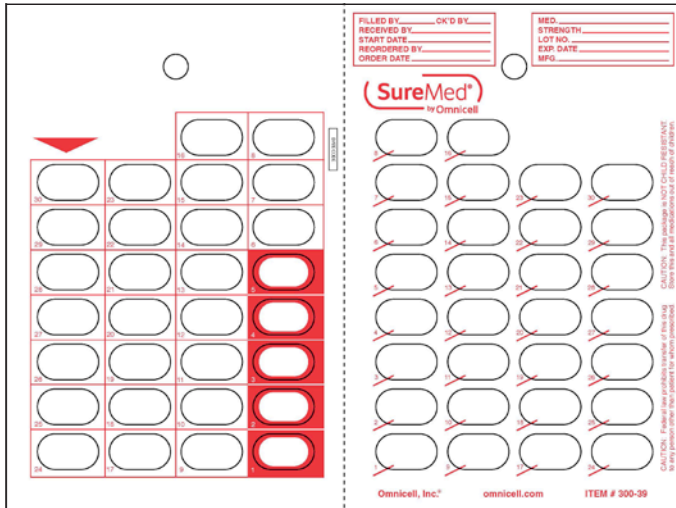

*XL blister requires deeper paddle.

Coordinating Blisters

Quantity: 1,000/Box

Item Number	Description
200-27	Small Blister
200-28	Medium Blister
200-30	Large Blister
200-51*	XL Blister
203-29	Small Amber Blister
203-32	Medium Amber Blister
203-34	Large Amber Blister

Recommended Accessories

Quantity: 1

Item Number	Description
655-30	Cork Sealing Template
655-30A*	Cork Sealing Template for XL Blisters
660-00	Cold Seal Roller

Refer to page 7 for blister sizes

Item 300-58

31-Dose Cold Seal Card

Quantity: 250/Box

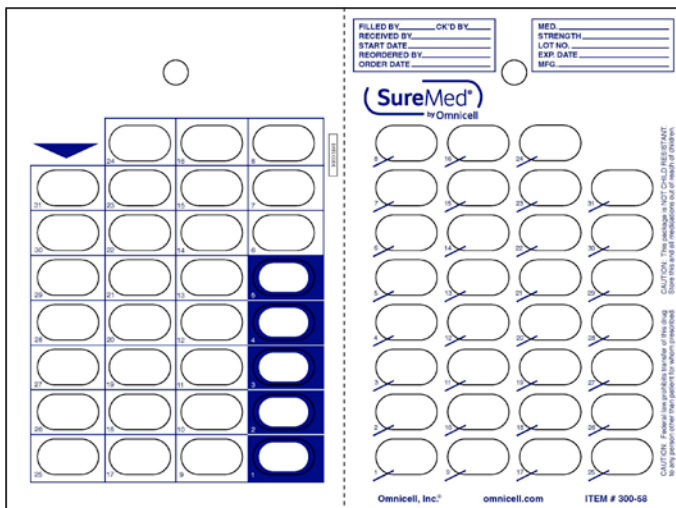

*XL blister requires deeper paddle.

Coordinating Blisters

Quantity: 1,000/Box

Item Number	Description
200-31	Small Blister
200-32	Medium Blister
200-34	Large Blister
200-52*	XL Blister
203-30	Small Amber Blister
203-31	Medium Amber Blister
203-33	Large Amber Blister

Recommended Accessories

Quantity: 1

Item Number	Description
655-30	Cork Sealing Template
655-30A*	Cork Sealing Template for XL Blisters
660-00	Cold Seal Roller

Refer to page 7 for blister sizes

Item 300-59

31-Dose Calendar Cold Seal Card

Quantity: 250/Box

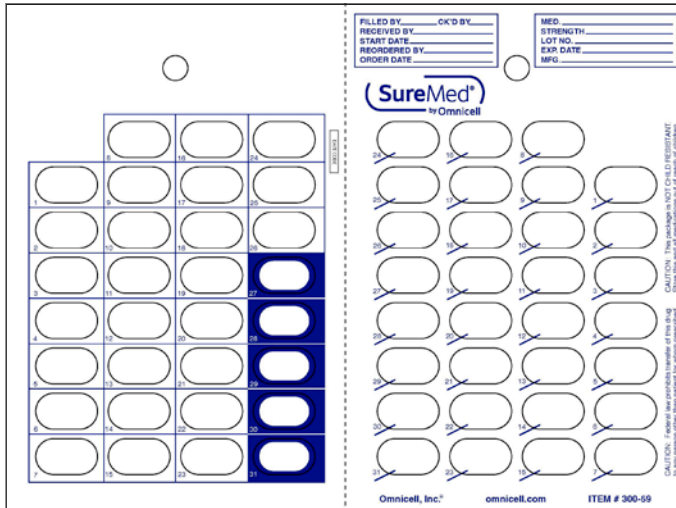

*XL blister requires deeper paddle.

Coordinating Blisters

Quantity: 1,000/Box

Item Number	Description
200-31	Small Blister
200-32	Medium Blister
200-34	Large Blister
200-52*	XL Blister
203-30	Small Amber Blister
203-31	Medium Amber Blister
203-33	Large Amber Blister

Recommended Accessories

Quantity: 1

Item Number	Description
655-30	Cork Sealing Template
655-30A*	Cork Sealing Template for XL Blisters
660-00	Cold Seal Roller

Refer to page 7 for blister sizes

Item 300-64

62-Dose Cold Seal Card

Quantity: 250/Box

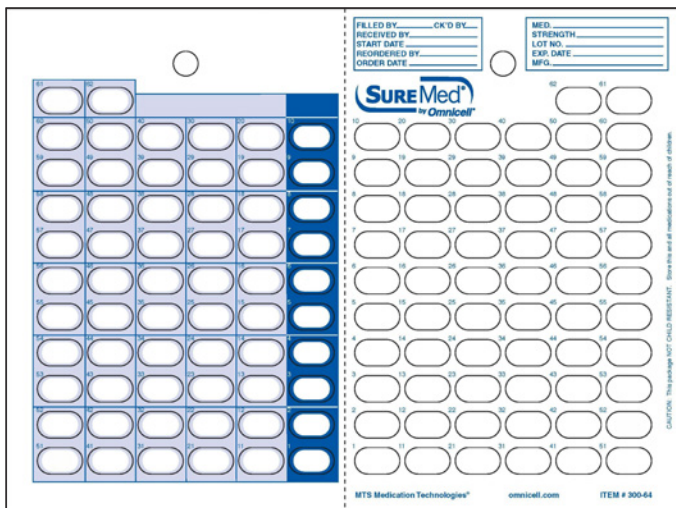

*XL blister requires deeper paddle.

Coordinating Blisters

Quantity: 1,000/Box

Item Number	Description
200-23	Blister
200-25	Amber Blister

Recommended Accessories

Quantity: 1

Item Number	Description
655-60	Cork Sealing Template
660-00	Cold Seal Roller

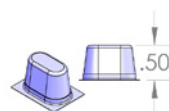

62-Dose Blister
.50"

Item 300-65

90-Dose Cold Seal Card

Quantity: 250/Box

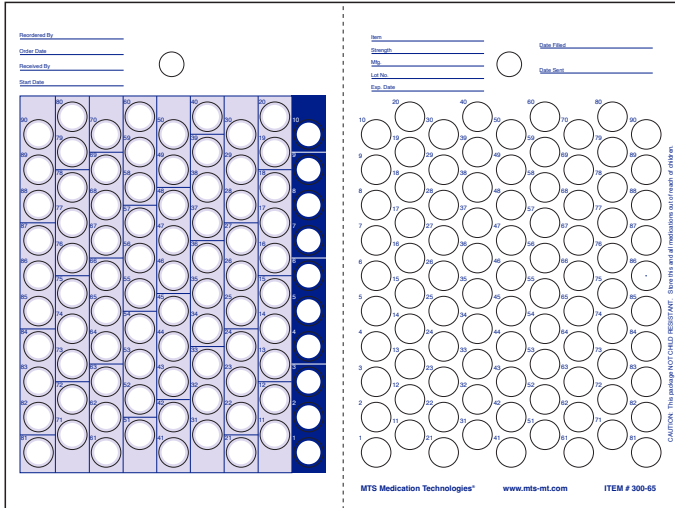

Coordinating Blisters

Quantity: 1,000/Box

Item Number	Description
200-24	Blister
203-26	Amber Blister

Recommended Accessories

Quantity: 1

Item Number	Description
655-90	Cork Sealing Template
660-00	Cold Seal Roller



Omniceil's 1-Piece cards come with pre-attached blisters, allowing for a simplified filling process.

Item 300-77 1-Piece Series

30-Dose 1-Piece Heat Seal Card

Quantity: 250/Box

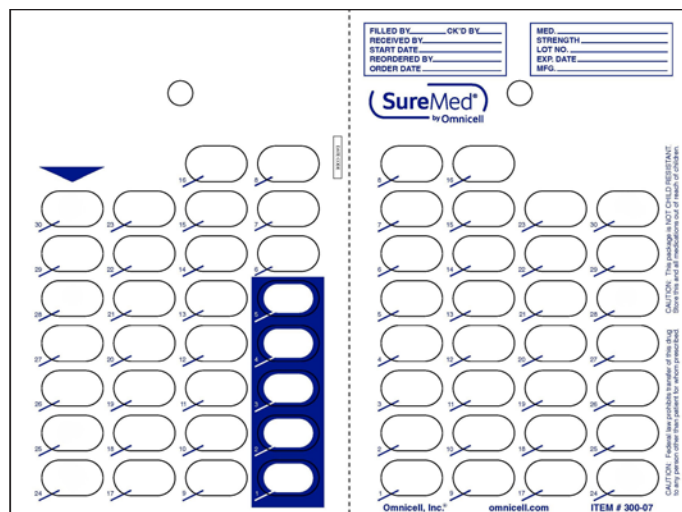

Cards

Item Number	Description
300-77-B30M	30-Dose 1-Piece Heat Seal Card: Medium Blister
300-77-B30OV	30-Dose 1-Piece Heat Seal Card: Large Blister
300-77-A30OV	30-Dose 1-Piece Heat Seal Card: Large Amber Blister

Recommended Accessories

Quantity: 1

Item Number	Description
651-32	Paddle 5/8" thick



Item 300-78 1-Piece Series

31-Dose 1-Piece Heat Seal Card

Quantity: 250/Box

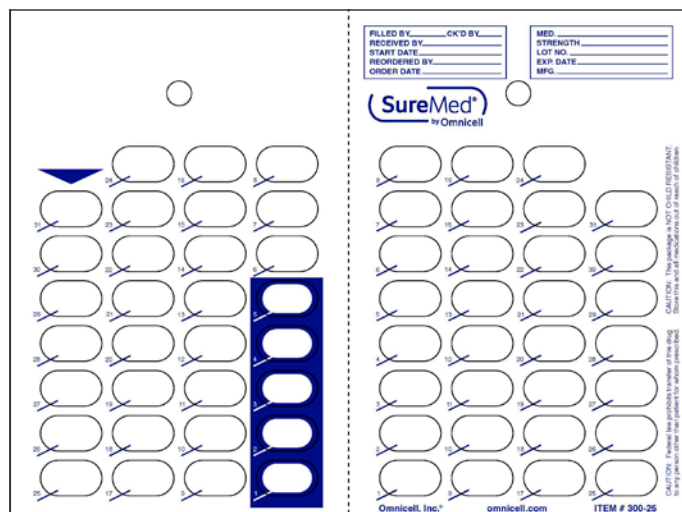

Cards

Item Number	Description
300-78-B31S	31-Dose 1-Piece Heat Seal Card: Small Blister
300-78-B31M	31-Dose 1-Piece Heat Seal Card: Medium Blister
300-78-B31OV	31-Dose 1-Piece Heat Seal Card: Large Blister
300-78-A31OV	30-Dose 1-Piece Heat Seal Card: Large Amber Blister

Recommended Accessories

Quantity: 1

Item Number	Description
651-32	Paddle 5/8" thick



Item 300-80-B60

60-Dose 1-Piece Heat Seal Card

Quantity: 250/Box

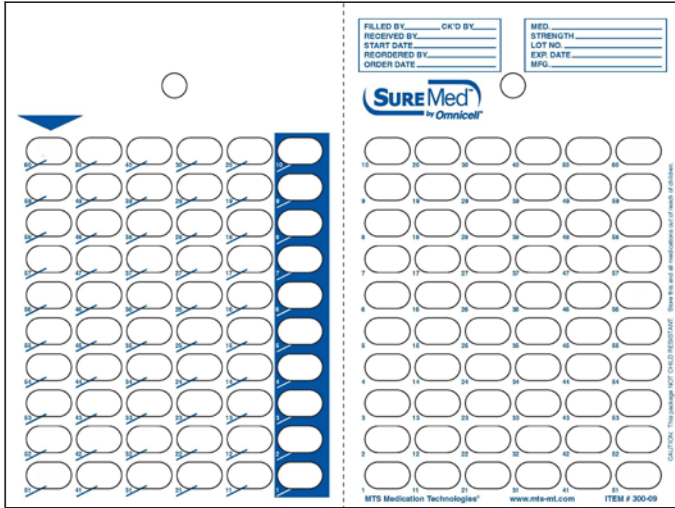

Recommended Accessories

Quantity: 1

Item Number	Description
651-62	60, 62 Dose Paddle 5/8" thick

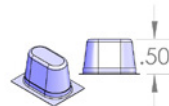

60-Dose Blister
.50"

Item 300-81-B62

62-Dose 1-Piece Heat Seal Card

Quantity: 250/Box

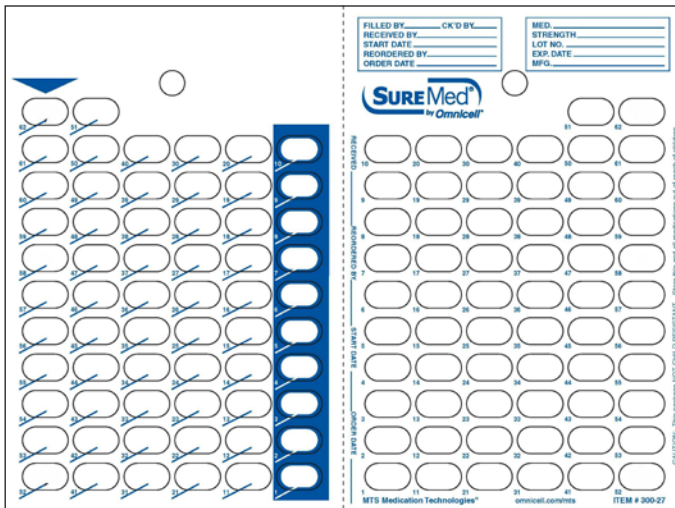

Recommended Accessories

Quantity: 1

Item Number	Description
651-62	60, 62 Dose Paddle 5/8" thick

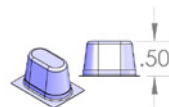

62-Dose Blister
.50"

Item 300-82-B90

90-Dose 1-Piece Heat Seal Card

Quantity: 250/Box

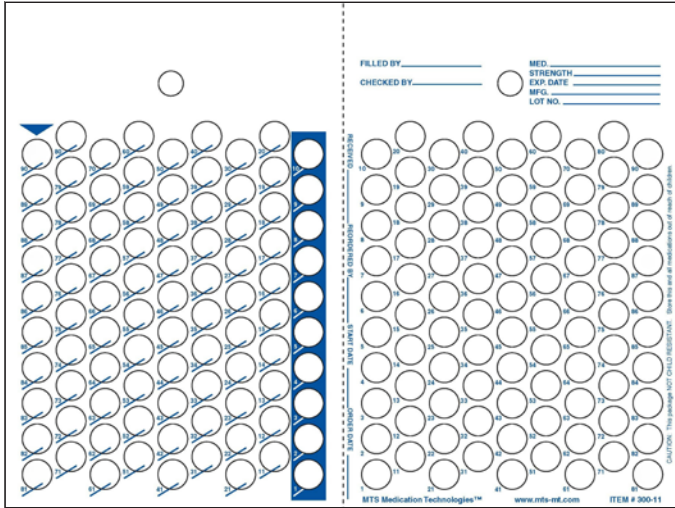

Recommended Accessories

Quantity: 1

Item Number	Description
651-92	90 Dose Paddle 5/8" thick



Item 300-91-B30S

30-Dose 1-Piece Cold Seal Card: Small Blister

Quantity: 250/Box

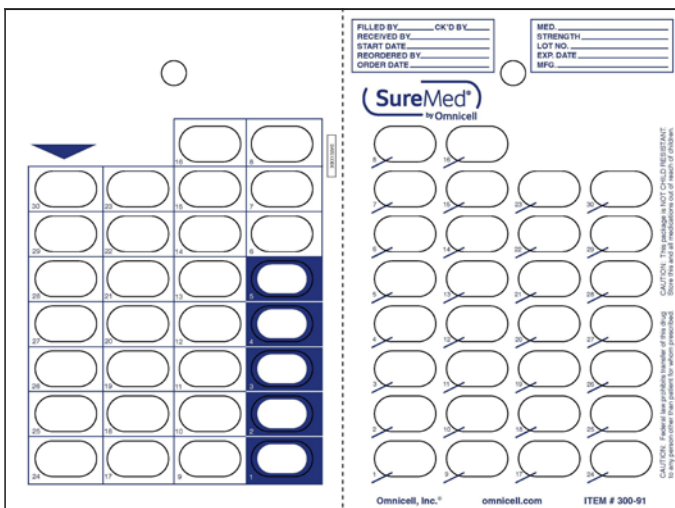

Recommended Accessories

Quantity: 1

Item Number	Description
655-30	Cork Sealing Template
660-00	Cold Seal Roller



*100 box minimum order requirement

Item 300-40 1-Piece Series

31-Dose 1-Piece Cold Seal Card

Quantity: 250/Box

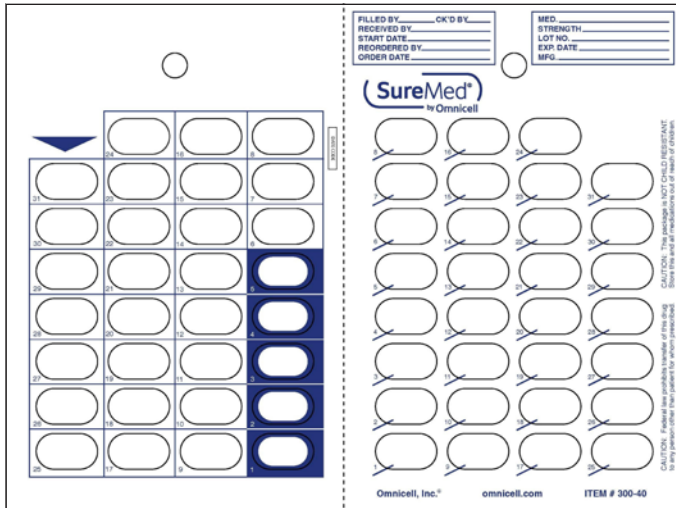

Cards

Item Number	Description
300-40-B31S	31-Dose 1-Piece Heat Seal Card: Small Blister
300-40-B31OV	31-Dose 1-Piece Heat Seal Card: Large Amber Blister

Recommended Accessories

Quantity: 1

Item Number	Description
655-30	Cork Sealing Template
660-00	Cold Seal Roller



Item 300-41-B62

62-Dose 1-Piece Cold Seal Card

Quantity: 250/Box

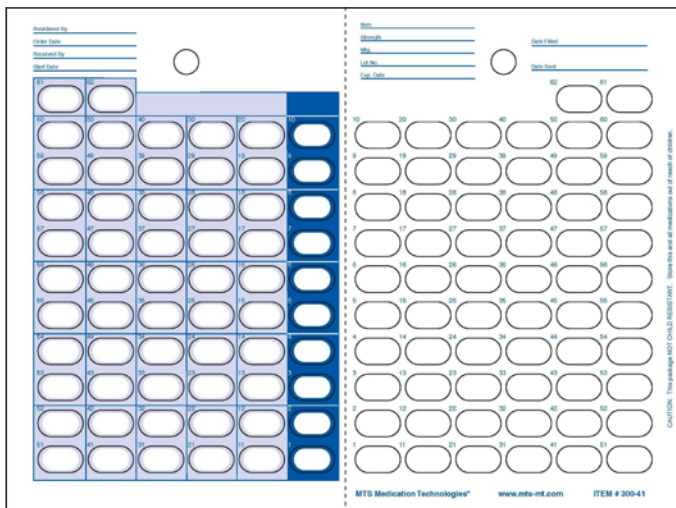

Recommended Accessories

Quantity: 1

Item Number	Description
655-60	Cork Sealing Template
660-00	Cold Seal Roller



62-Dose Blister
.50"

Item 300-42-B90

90-Dose 1-Piece Cold Seal Card

Quantity: 250/Box

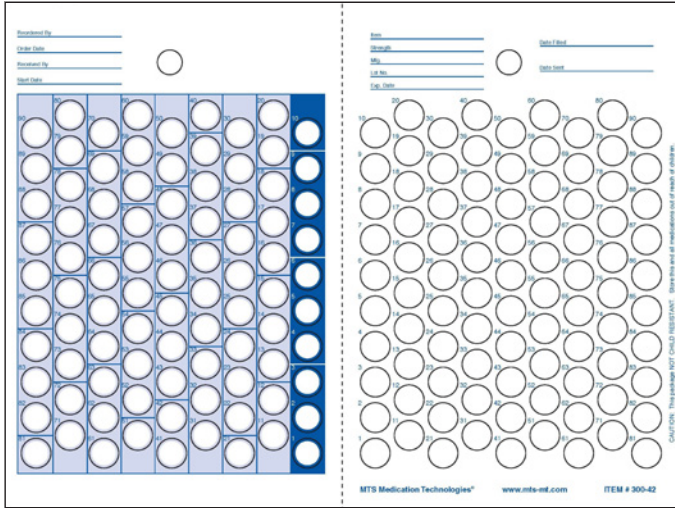

Recommended Accessories

Quantity: 1

Item Number	Description
655-90	Cork Sealing Template
660-00	Cold Seal Roller



Reclaimable Select Seal™ Cards Designed with a special select seal adhesive pattern and a perforated card used for the recovery of unused medications without damaging the blister or printed foil.

Non-Reclaimable Med Cards Provides a method for repackaging of returned unit doses to allow medication to be redistributed in a new card.



Reclaimable Select Seal Card



Non-Reclaimable Med Card

Item 300-13

30-Dose Select Seal Card

Quantity: 500/Box

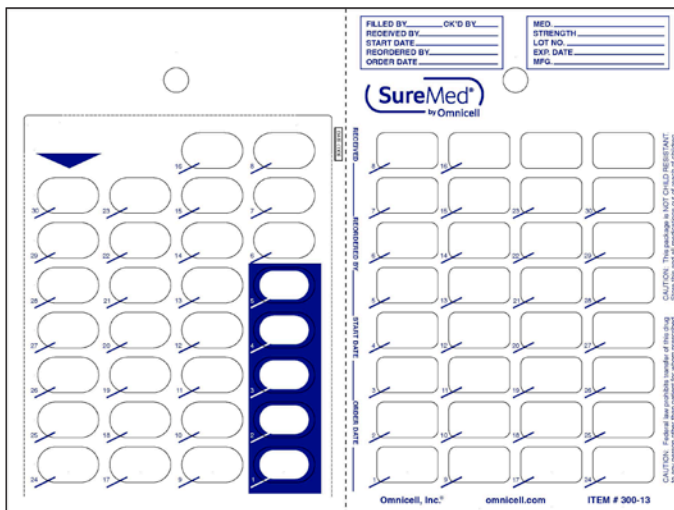

Coordinating Blisters

Quantity: 1,000/Box

Item Number	Description
201-10-30	30-Dose Small Perforated: Unit Dose Blister
201-11-30	30-Dose Medium Perforated: Unit Dose Blister
201-13-30	30-Dose Large Perforated: Unit Dose Blister
201-13XL-30	30-Dose XL Perforated: Unit Dose Blister
203-10-30	30-Dose Small Amber Perforated: Unit Dose Blister
203-11-30	30-Dose Medium Amber Perforated: Unit Dose Blister
203-16-30	30-Dose Large Amber Perforated: Unit Dose Blister
203-13XL-30	30-Dose XL Amber Perforated: Unit Dose Blister

[Refer to page 37 for Unit Dose Foil & Accessories](#)

Item 300-14

31-Dose Select Seal Card

Quantity: 500/Box

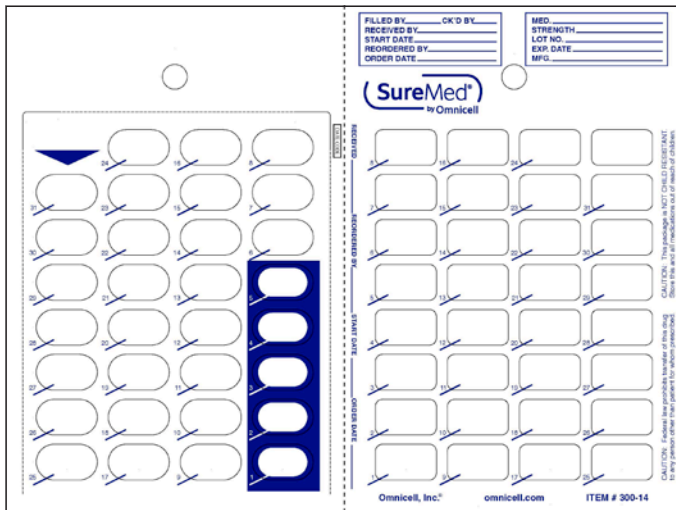

Coordinating Blisters

Quantity: 1,000/Box

Item Number	Description
201-10-31	31-Dose Small Perforated: Unit Dose Blister
201-11-31	31-Dose Medium Perforated: Unit Dose Blister
201-13-31	31-Dose Large Perforated: Unit Dose Blister
201-13XL-31	31-Dose XL Perforated: Unit Dose Blister
203-10	32-Dose Small Amber Perforated: Unit Dose Blister
203-11	32-Dose Medium Amber Perforated: Unit Dose Blister
203-16	32-Dose Large Amber Perforated: Unit Dose Blister

Refer to page 37 for Unit Dose Foil & Accessories

Item 300-15

32-Dose Select Seal Card

Quantity: 500/Box

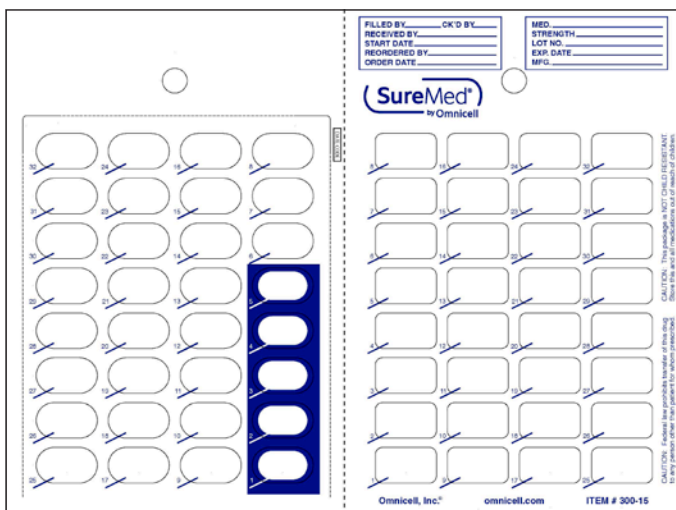

Coordinating Blisters

Quantity: 1,000/Box

Item Number	Description
201-10	32-Dose Small Perforated: Unit Dose Blister
201-11	32-Dose Medium Perforated: Unit Dose Blister
201-13	32-Dose Large Perforated: Unit Dose Blister
201-13XL	32-Dose XL Perforated: Unit Dose Blister
203-10	32-Dose Small Amber Perforated: Unit Dose Blister
203-11	32-Dose Medium Amber Perforated: Unit Dose Blister
203-16	32-Dose Large Amber Perforated: Unit Dose Blister

Refer to page 37 for Unit Dose Foil & Accessories

Item 300-32

7 or 14-Day Select Seal Card

Quantity: 500/Box

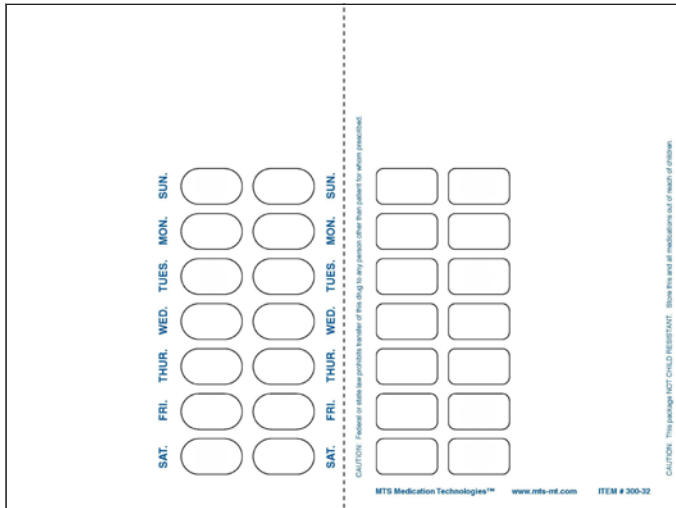

Coordinating Blisters

Quantity: 1,000/Box

Item Number	Description
201-05	Large Perforated: Unit Dose Blister

Refer to page 37 for Unit Dose Foil & Accessories

Item 300-73

30-Dose Med Card

Quantity: 500/Box

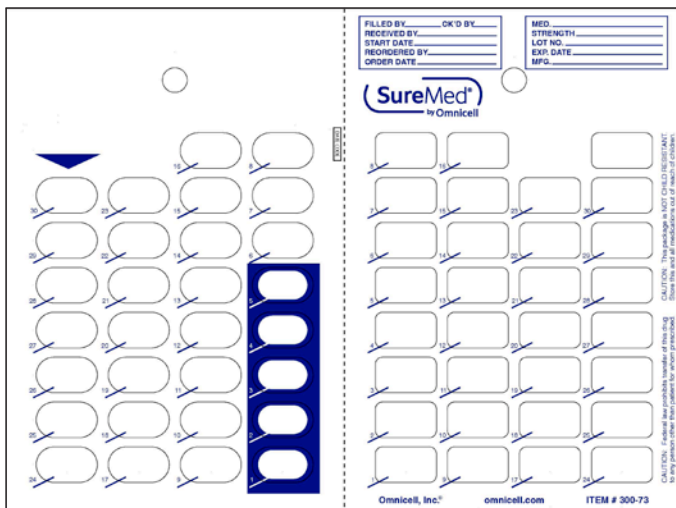

Coordinating Blisters

Quantity: 1,000/Box

Item Number	Description
201-10-30	30-Dose Small Perforated: Unit Dose Blister
201-11-30	30-Dose Medium Perforated: Unit Dose Blister
201-13-30	30-Dose Large Perforated: Unit Dose Blister
201-13XL-30	30-Dose XL Perforated: Unit Dose Blister
203-10-30	30-Dose Small Amber Perforated: Unit Dose Blister
203-11-30	30-Dose Medium Amber Perforated: Unit Dose Blister
203-16-30	30-Dose Large Amber Perforated: Unit Dose Blister
203-13XL-30	30-Dose XL Amber Perforated: Unit Dose Blister

Refer to page 37 for Unit Dose Foil & Accessories

Item 300-70

31-Dose Med Card

Quantity: 500/Box

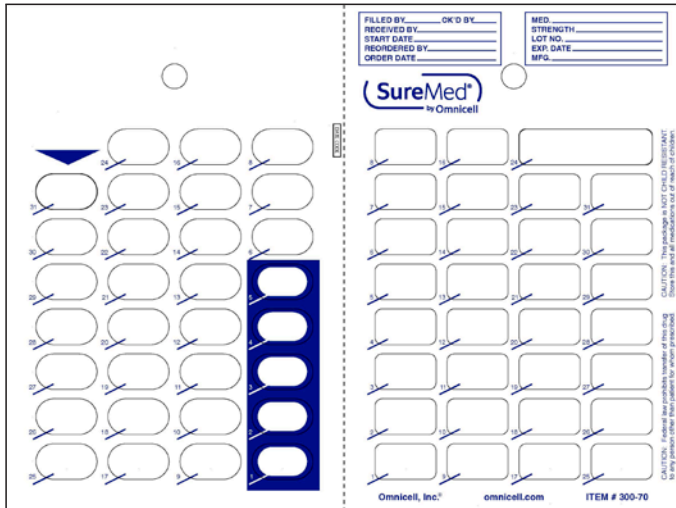

Coordinating Blisters

Quantity: 1,000/Box

Item Number	Description
201-10-31	31-Dose Small Perforated: Unit Dose Blister
201-11-31	31-Dose Medium Perforated: Unit Dose Blister
201-13-31	31-Dose Large Perforated: Unit Dose Blister
201-13XL-31	31-Dose XL Perforated: Unit Dose Blister
203-10	32-Dose Small Amber Perforated: Unit Dose Blister
203-11	32-Dose Medium Amber Perforated: Unit Dose Blister
203-16	32-Dose Large Amber Perforated: Unit Dose Blister

Refer to page 37 for Unit Dose Foil & Accessories

Item 300-72

32-Dose Med Card

Quantity: 500/Box

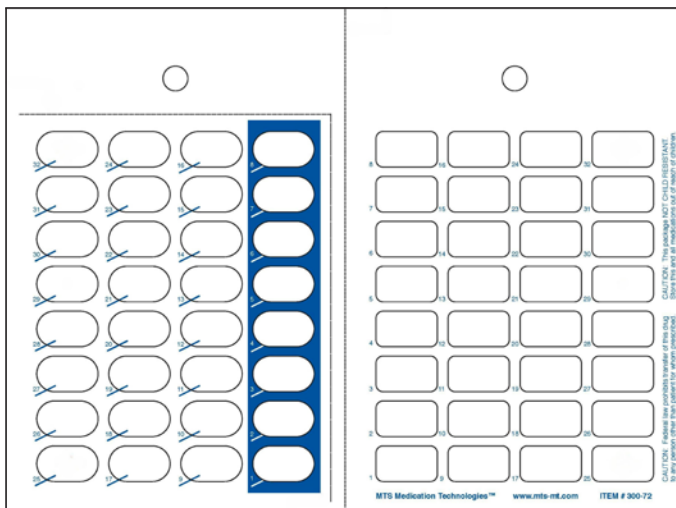

Coordinating Blisters

Quantity: 1,000/Box

Item Number	Description
201-10	32-Dose Small Perforated: Unit Dose Blister
201-11	32-Dose Medium Perforated: Unit Dose Blister
201-13	32-Dose Large Perforated: Unit Dose Blister
201-13XL	32-Dose XL Perforated: Unit Dose Blister
203-10	32-Dose Small Amber Perforated: Unit Dose Blister
203-11	32-Dose Medium Amber Perforated: Unit Dose Blister
203-16	32-Dose Large Amber Perforated: Unit Dose Blister

Refer to page 37 for Unit Dose Foil & Accessories

Item 300-74

30-Dose Cold Seal Med Card

Quantity: 250/Box

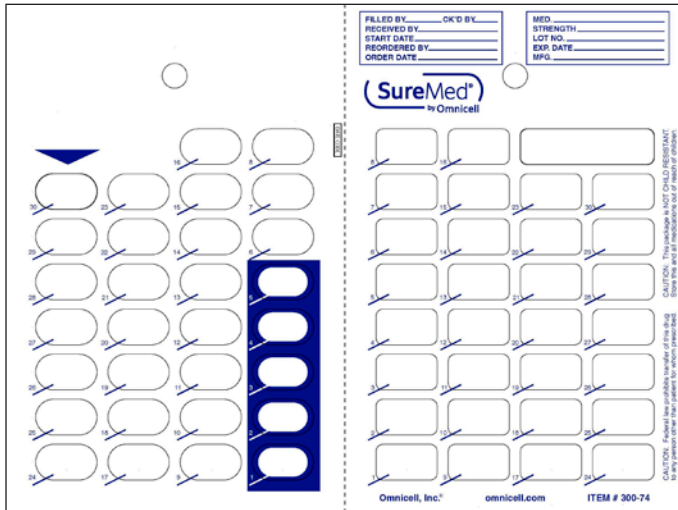

Coordinating Blisters

Quantity: 1,000/Box

Item Number	Description
201-10-30	30-Dose Small Perforated: Unit Dose Blister
201-11-30	30-Dose Medium Perforated: Unit Dose Blister
201-13-30	30-Dose Large Perforated: Unit Dose Blister
201-13XL-30	30-Dose XL Perforated: Unit Dose Blister
203-16-30	30-Dose Large Amber Perforated: Unit Dose Blister

Refer to page 37 for Unit Dose Foil & Accessories

Item 300-67

30-Dose Mini Heat Seal Control Card

Quantity: 500/Box

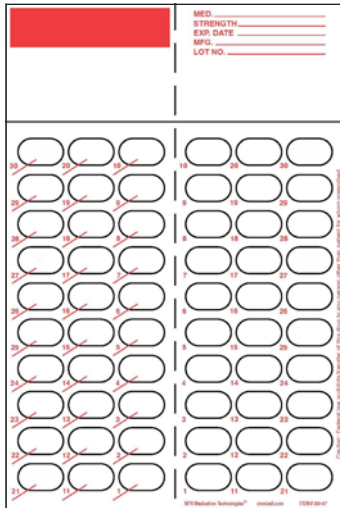

Coordinating Blisters

Quantity: 1,000/Box

Item Number	Description
200-22	Mini Blister
200-21	Mini Amber Blister

Recommended Accessories

Quantity: 1

Item Number	Description
651-37	Mini 30-Dose 4-Up Paddle

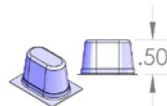

Mini Blister
.50"

Item 302-15

31-Dose Heat Seal Red Card

Quantity: 500/Box

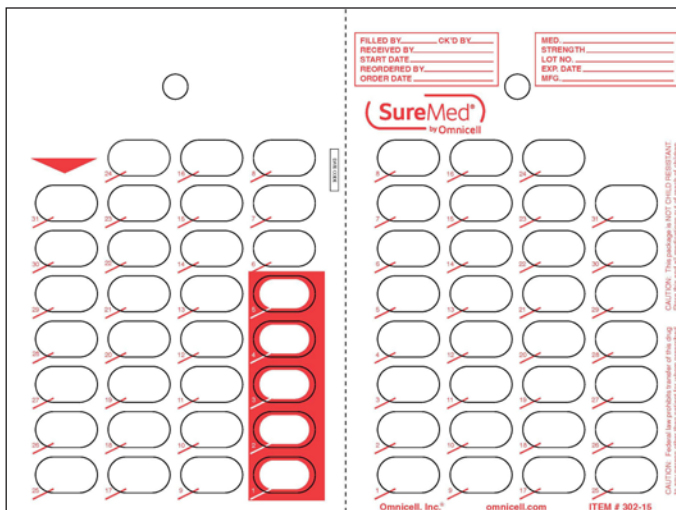

Coordinating Blisters

Quantity: 1,000/Box

Item Number	Description
200-31	Small Blisters
200-32	Medium Blisters
200-34	32-Dose Large Blisters
200-52*	32-Dose XL Blisters
203-30	Small Amber Blisters
203-31	Medium Amber Blisters
203-33	Large Amber Blisters

Recommended Accessories

Quantity: 1

Item Number	Description
651-32	Paddle 7/8" thick
651-31*	Dose Paddle for XL Blister

Refer to page 7 for blister sizes

*XL Blister Requires XL Paddle

Item 302-11

62-Dose Heat Seal Red Card

Quantity: 500/Box

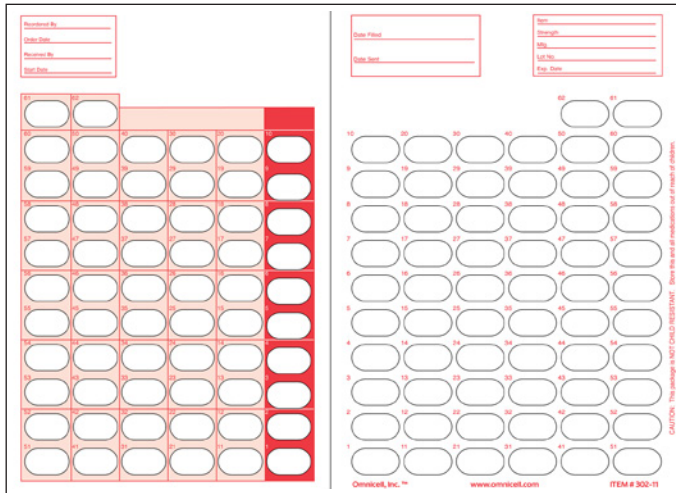

Coordinating Blisters

Quantity: 1,000/Box

Item Number	Description
200-23	Blister
203-25	Amber Blister

Recommended Accessories

Quantity: 1

Item Number	Description
651-62	60, 62-Dose Paddle 5/8" thick

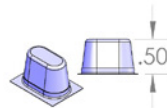

62-Dose Blister
.50"

Item 302-14

31-Dose Heat Seal Narrow Red Card

Quantity: 500/Box

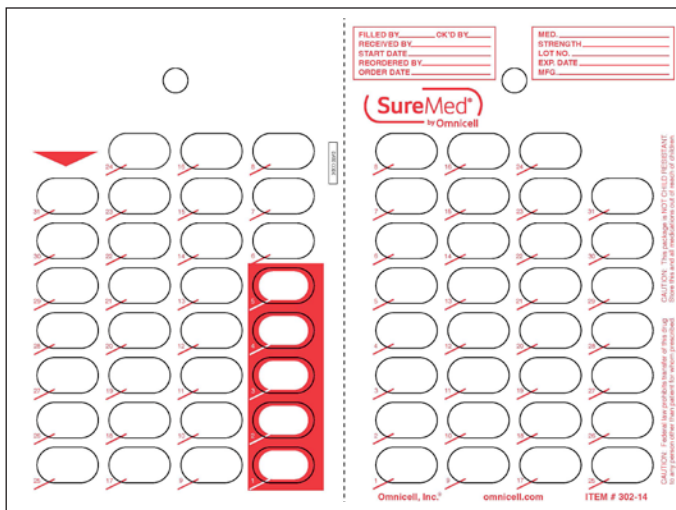

Coordinating Blisters

Quantity: 1,000/Box

Item Number	Description
200-31	Small Blisters
200-32	Medium Blisters
200-34	32-Dose Large Blisters
200-52*	32-Dose XL Blisters
203-30	Small Amber Blisters
203-31	Medium Amber Blisters
203-33	Large Amber Blisters

Recommended Accessories

Quantity: 1

Item Number	Description
651-32	Paddle 7/8" thick
651-31*	Dose Paddle for XL Blister

Refer to page 7 for blister sizes

*XL Blister Requires XL Paddle

Item 300-61

30-Dose Trap Door Red Card

Quantity: 500/Box

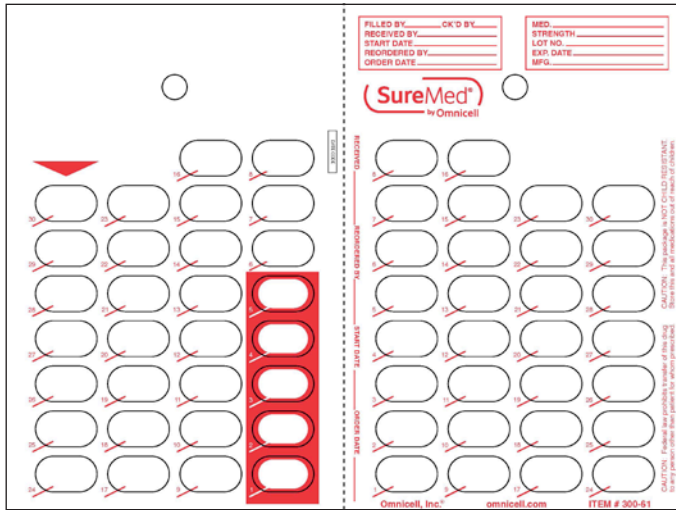

Coordinating Blisters

Quantity: 1,000/Box

Item Number	Description
200-27	Small Blister
200-28	Medium Blister
200-30	Large Blister
200-51*	XL Blister
203-29	Small Amber Blister
203-32	Medium Amber Blister
203-34	Large Amber Blister

Recommended Accessories

Quantity: 1

Item Number	Description
651-32	Paddle 7/8" thick
651-31*	Dose Paddle for XL Blister

Refer to page 7 for blister sizes

*XL Blister Requires XL Paddle

Item 300-63

60-Dose Trap Door Red Card

Quantity: 500/Box

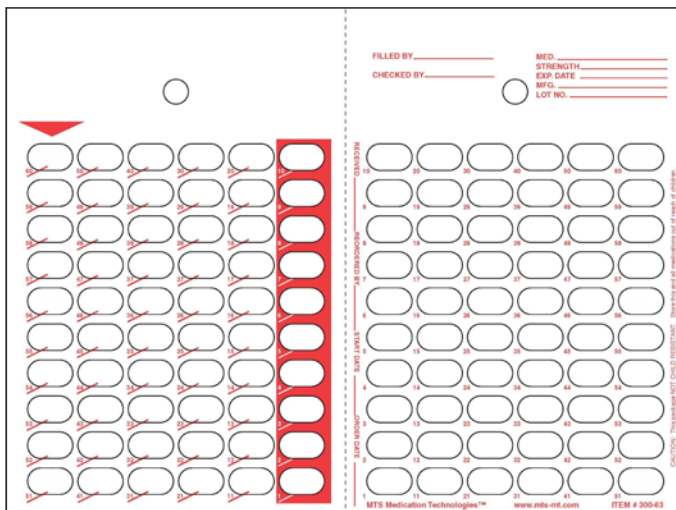

Coordinating Blisters

Quantity: 1,000/Box

Item Number	Description
200-60	Blister
203-60	Amber Blister

Recommended Accessories

Quantity: 1

Item Number	Description
651-62	60, 62-Dose Paddle 5/8" thick



60-Dose Blister
.50"

Mealtime Cards 31-day calendar mealtime cards come in various colors to visually distinguish morning, afternoon, evening, and bedtime medication passes. A white PRN card is also available.



Mealtime Cards

Quantity: 500/Box

Item Number	Description
300-43	Mealtime Heat Seal Morning Card: Orange
300-44	Mealtime Heat Seal Afternoon Card: Green
300-45	Mealtime Heat Seal Evening Card: Red
300-45Y	Mealtime Heat Seal Evening Card: Yellow
300-46	Mealtime Heat Seal Bedtime Card: Blue
300-47	Mealtime Heat Seal PRN Card: White

Coordinating Blisters

Quantity: 1,000/Box

Item Number	Description
200-31	Small Blisters
200-32	Medium Blisters
200-34	32-Dose Large Blisters
200-52*	32-Dose XL Blisters
203-30	Small Amber Blisters
203-31	Medium Amber Blisters
203-33	Large Amber Blisters

Recommended Accessories

Quantity: 1

Item Number	Description
651-32	Paddle 7/8" thick
651-31*	Dose Paddle for XL Blister

*XL Blister Requires XL Paddle

[Refer to page 7 for blister sizes](#)

Item 300-18

7 or 14-Day Heat Seal Red Card

Quantity: 500/Box

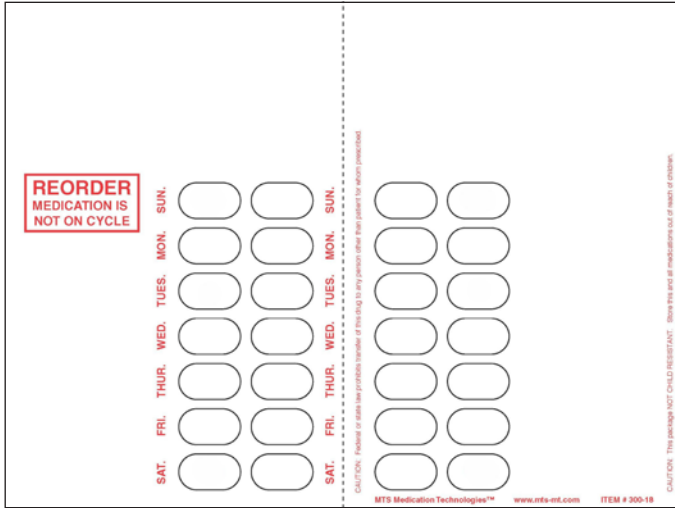

Coordinating Blisters

Quantity: 1,000/Box

Item Number	Description
201-05	Large Perforated: Unit Dose Blister

Recommended Accessories

Quantity: 1

Item Number	Description
651-32	Paddle 5/8" thick

Refer to page 37 for unit dose blister sizes

Item 300-19

7 or 14-Day Heat Seal Blue Card

Quantity: 500/Box

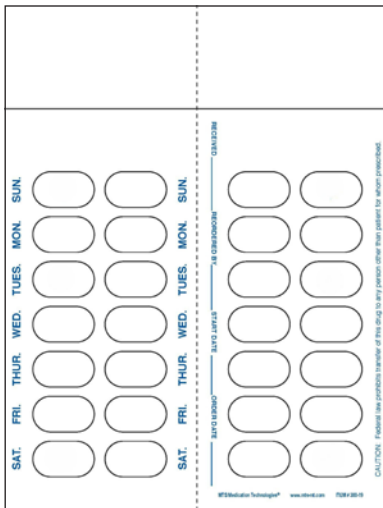

Coordinating Blisters

Quantity: 1,000/Box

Item Number	Description
201-05	Large Perforated: Unit Dose Blister

Recommended Accessories

Quantity: 1

Item Number	Description
651-32	Paddle 5/8" thick

Refer to page 37 for unit dose blister sizes

Item 300-36

15 or 16-Dose Heat Seal Card

Quantity: 500/Box

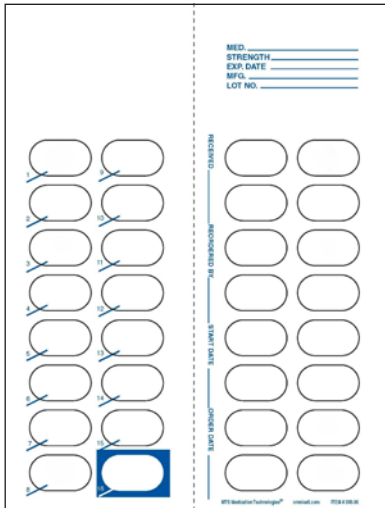

*XL Blister Requires XL Paddle

Coordinating Blisters

Quantity: 1,000/Box

Item Number	Description
201-10	Small Perforated: Unit Dose Blister
201-11	Medium Perforated: Unit Dose Blister
201-13	Large Perforated: Unit Dose Blister
201-13XL	XL Perforated: Unit Dose Blister
203-16	Large Amber Perforated: Unit Dose Blister

Recommended Accessories

Quantity: 1

Item Number	Description
651-32	Paddle 7/8" thick
651-31*	Dose Paddle for XL Blister

Refer to page 37 for unit dose blister sizes

Item 314-51

14-Dose Heat Seal Card

Quantity: 500/Box

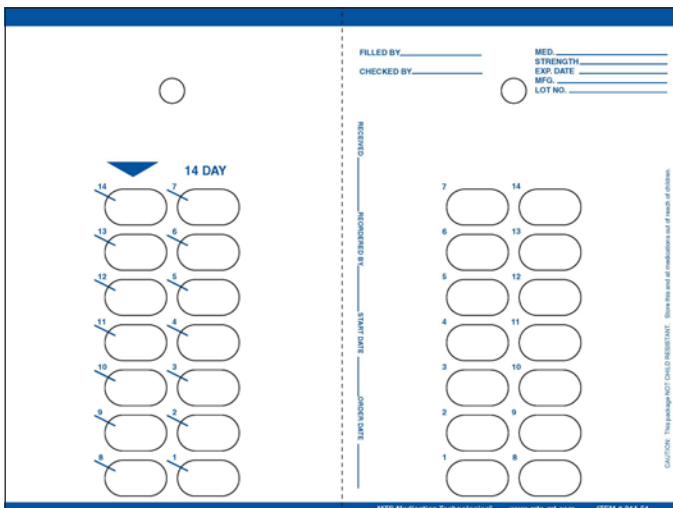

*XL Blister Requires XL Paddle

Coordinating Blisters

Quantity: 1,000/Box

Item Number	Description
201-05	Large Perforated: Unit Dose Blister

Recommended Accessories

Quantity: 1

Item Number	Description
651-32	Paddle 5/8" thick

Refer to page 37 for unit dose blister sizes

Item 314-61

14-Dose Cold Seal Card

Quantity: 250/Box

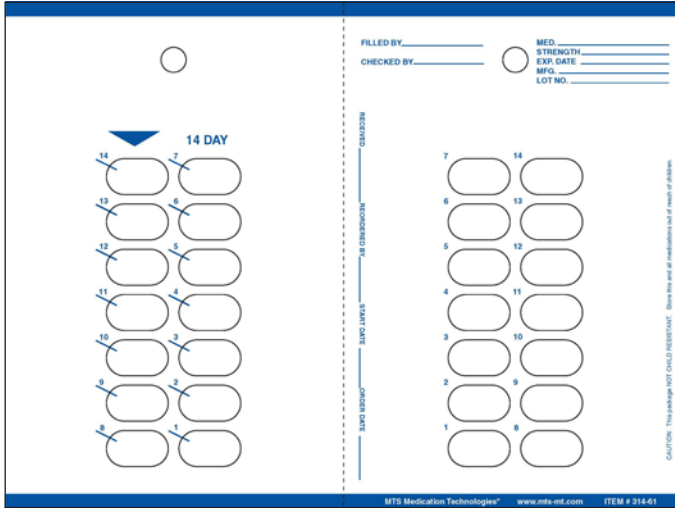

Coordinating Blisters

Quantity: 1,000/Box

Item Number	Description
201-05	Large Perforated: Unit Dose Blister

Recommended Accessories

Quantity: 1

Item Number	Description
655-30	Cork Sealing Template
660-00	Cold Seal Roller

Refer to page 37 for unit dose blister sizes

Omniceil's Opti-Pak™ System offers a disposable, color-coded compliance package with automated filling and sealing capabilities. This system presents a practical compliance packaging solution for the pharmacy, home, and resident.



Item 301-08

8 or 16-Day Heat Seal Card:
Days of the Week

Quantity: 1,000/Box

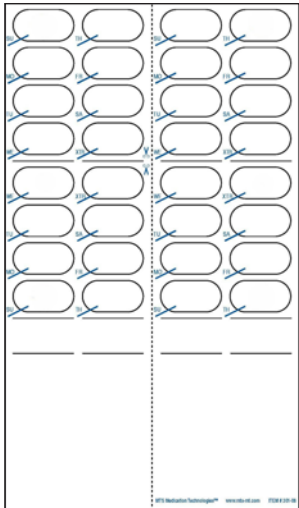

Item 301-09

8 or 16-Day Heat Seal Card:
PRN

Quantity: 1,000/Box

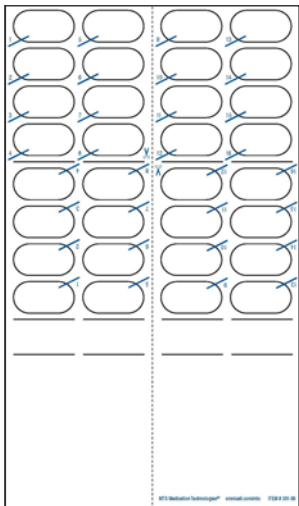

Coordinating Blisters

Quantity: 1,000/Box

Item Number	Description
204-08	Opti-Pak Blister

Recommended Accessories

Quantity: 1

Item Number	Description
651-44	Opti-Pak 4-Up Paddle

Quantity: 100/Box

Item Number	Description
671-01	Opti-Pak Storage Containers

Quantity: 5,000/Box

Item Number	Description
L-301-B1	Opti-Pak Label Pink: 7:00 AM–10:00 AM
L-301-B2	Opti-Pak Label Yellow: 11:00 AM–1:00 PM
L-301-B3	Opti-Pak Label Green: 2:00 PM–4:00 PM
L-301-B4	Opti-Pak Label Orange: 5:00 PM–7:00 PM
L-301-B5	Opti-Pak Label Gray: 8:00 PM–10:00 PM
L-301-B6	Opti-Pak Label Purple: 11:00 PM–6:00 AM
L-301-B7	Opti-Pak Label Red: PRN
L-301-B8	Opti-Pak Label Blue: Control

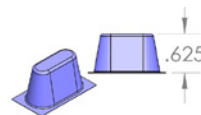

Opti-Pak Blister
.625"

Unit Dose Solutions



Omnicell's Unit Dose foil labeling system and supporting consumables, enable pharmacies to efficiently print, package, and seal medications into a unit dose form factor. This system is designed to support packaging of oral solids into single dose consumables for use in unit dose box, e-kits and automated dispensing cabinets, and reclaimable and non-reclaimable blister cards.

Blister Sizes & Accessories

We offer a variety of blisters in standard clear and amber. Standard Unit Dose Perforated Blisters are produced 32 per sheet (4x8). Select blister sizes are available in 14, 28, 30, and 31-dose.

Blister Sizes Small | Medium | Large | XL

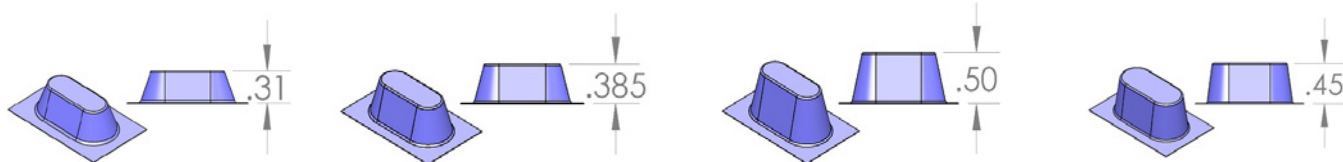

Small Blister
.31"

Medium Blister
.385"

Large Blister
.50"

XL Blister
.45"



Designed to nest together to optimize box, cart, and shelf space.

Does not nest.

Unit Dose Foil



Item 680-11*
Thermal Transfer Foil:
with Pin feed
1,000/Roll



Item 680-19
Thermal Transfer Foil:
1-Step for
Select Seal Card
1,000/Roll

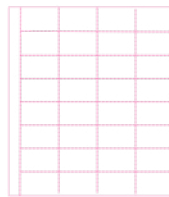

Item 680-19-3
Thermal Transfer Foil:
1-Step for
Select Seal/EII/EIII
2,500/Roll

Recommended Accessories



Item 651-94*
Unit Dose 2-Up
Paddle with Pins



Item 586-33
Unit Dose Platen
with Pins for
MTS-350

*Unit dose paddle with pins needed for sealing

Unit Dose Boxes



Item UD-250
Unit Dose Box:
5" x 1 5/8" x 2 1/4"
Quantity: 1,000/Box



Item UD-251
Unit Dose Box:
4 11/16" x 1 9/16" x 2 3/8"
Quantity: 1,000/Box

Reorder Alert Cards



Item UD-286
Reorder Alert Cards
1,000/Box

Reclaimable Select Seal™ Cards Designed with a special select seal adhesive pattern and a perforated card designed for the recovery of unused medications without damaging the blister or printed foil.

Item 300-13

30-Dose Select Seal Card

Quantity: 500/Box

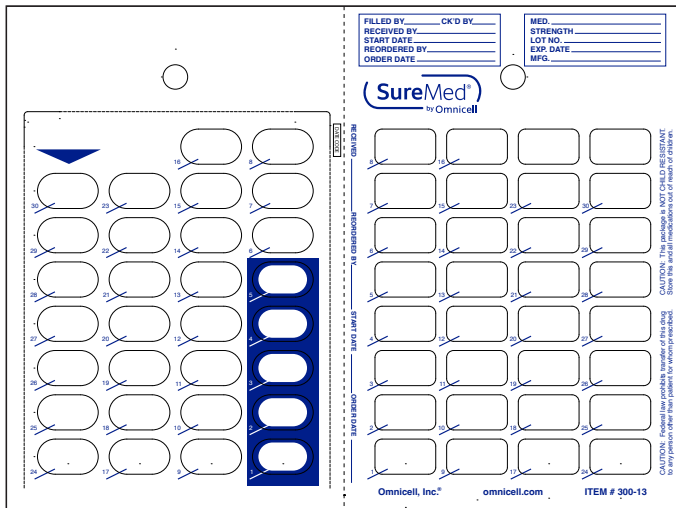

Coordinating Blisters

Quantity: 1,000/Box

Item Number	Description
201-10-30	30-Dose Small Perforated: Unit Dose Blister
201-11-30	30-Dose Medium Perforated: Unit Dose Blister
201-13-30	30-Dose Large Perforated: Unit Dose Blister
201-13XL-30	30-Dose XL Perforated: Unit Dose Blister
203-10-30	30-Dose Small Amber Perforated: Unit Dose Blister
203-11-30	30-Dose Medium Amber Perforated: Unit Dose Blister
203-16-30	30-Dose Large Amber Perforated: Unit Dose Blister
203-13XL-30	30-Dose XL Amber Perforated: Unit Dose Blister

Refer to page 37 for unit dose blister sizes

Item 300-14

31-Dose Select Seal Card

Quantity: 500/Box

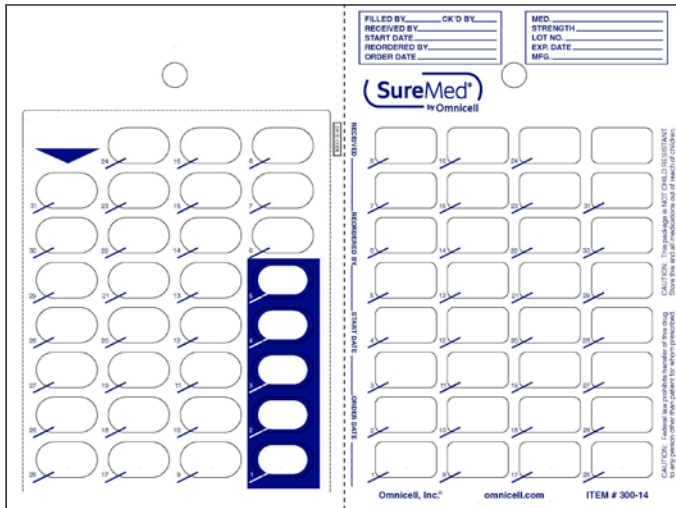

Coordinating Blisters

Quantity: 1,000/Box

Item Number	Description
201-10-31	31-Dose Small Perforated: Unit Dose Blister
201-11-31	31-Dose Medium Perforated: Unit Dose Blister
201-13-31	31-Dose Large Perforated: Unit Dose Blister
201-13XL-31	31-Dose XL Perforated: Unit Dose Blister
203-16	32-Dose Large Amber Perforated: Unit Dose Blister

Refer to page 37 for unit dose blister sizes

Item 300-15

32-Dose Select Seal Card

Quantity: 500/Box

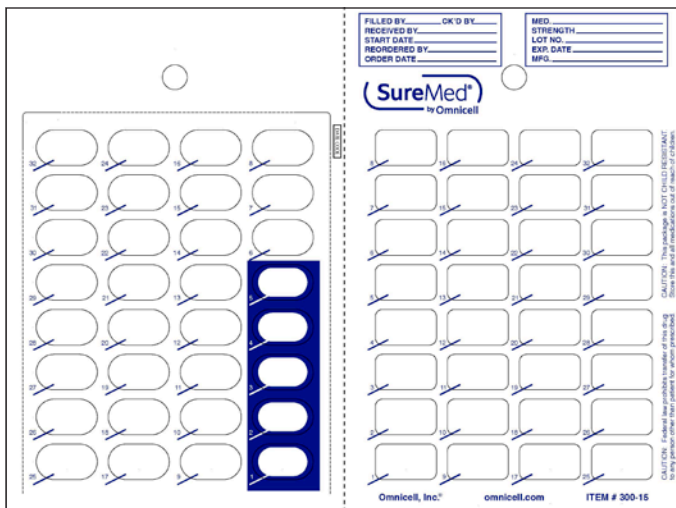

Coordinating Blisters

Quantity: 1,000/Box

Item Number	Description
201-10	32-Dose Small Perforated: Unit Dose Blister
201-11	32-Dose Medium Perforated: Unit Dose Blister
201-13	32-Dose Large Perforated: Unit Dose Blister
201-13XL	32-Dose XL Perforated: Unit Dose Blister
203-16	32-Dose Large Amber Perforated: Unit Dose Blister

Refer to page 37 for unit dose blister sizes

Non-reclaimable Med Cards Provides a method for repackaging of returned unit doses to allow medication to be redistributed in a new card.

Item 300-73

30-Dose Med Card

Quantity: 500/Box

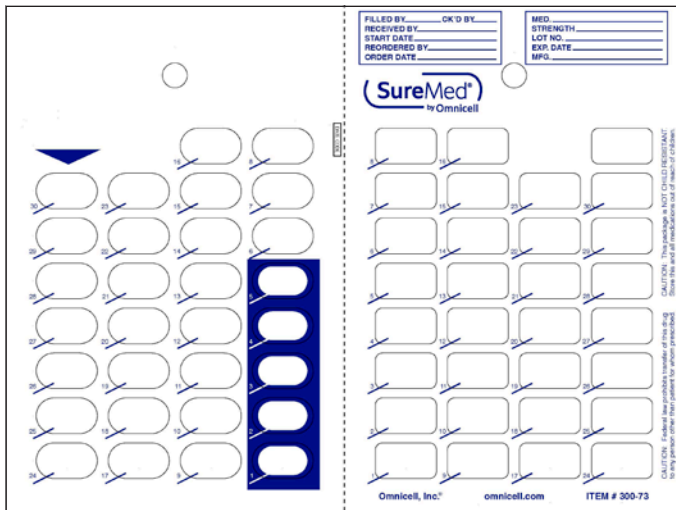

Coordinating Blisters

Quantity: 1,000/Box

Item Number	Description
201-10-30	30-Dose Small Perforated: Unit Dose Blister
201-11-30	30-Dose Medium Perforated: Unit Dose Blister
201-13-30	30-Dose Large Perforated: Unit Dose Blister
201-13XL-30	30-Dose XL Perforated: Unit Dose Blister
203-10-30	30-Dose Small Amber Perforated: Unit Dose Blister
203-11-30	30-Dose Medium Amber Perforated: Unit Dose Blister
203-16-30	30-Dose Large Amber Perforated: Unit Dose Blister
203-13XL-30	30-Dose XL Amber Perforated: Unit Dose Blister

Refer to page 37 for unit dose blister sizes

Item 300-70

31-Dose Med Card

Quantity: 500/Box

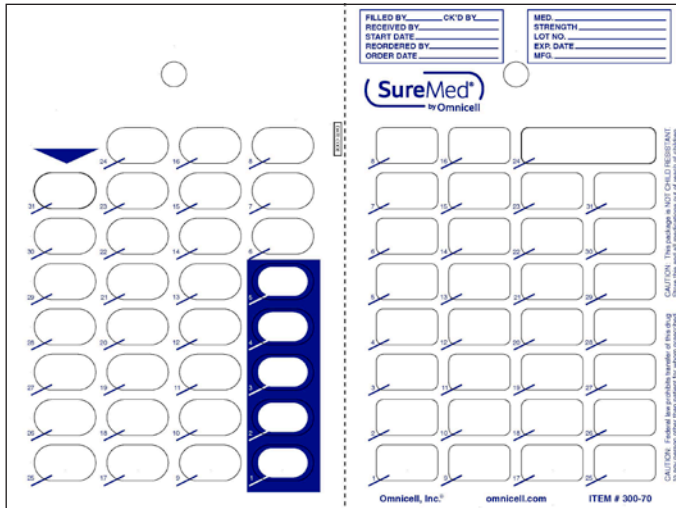

Coordinating Blisters

Quantity: 1,000/Box

Item Number	Description
201-10-31	31-Dose Small Perforated: Unit Dose Blister
201-11-31	31-Dose Medium Perforated: Unit Dose Blister
201-13-31	31-Dose Large Perforated: Unit Dose Blister
201-13XL-31	31-Dose XL Perforated: Unit Dose Blister
203-10	32-Dose Small Amber Perforated: Unit Dose Blister
203-11	32-Dose Medium Amber Perforated: Unit Dose Blister
203-16	32-Dose Large Amber Perforated: Unit Dose Blister

Refer to page 37 for unit dose blister sizes

Item 300-74

30-Dose Cold Seal Med Card

Quantity: 250/Box

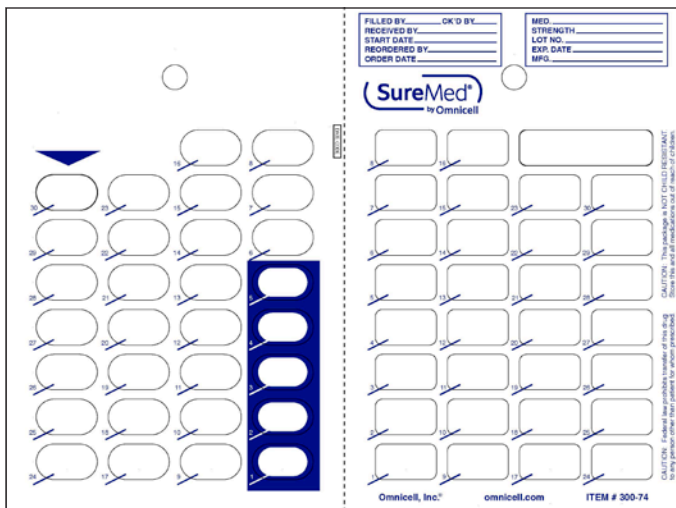

Coordinating Blisters

Quantity: 1,000/Box

Item Number	Description
201-10-30	30-Dose Small Perforated: Unit Dose Blister
201-11-30	30-Dose Medium Perforated: Unit Dose Blister
201-13-30	30-Dose Large Perforated: Unit Dose Blister
201-13XL-30	30-Dose XL Perforated: Unit Dose Blister
203-10-30	30-Dose Small Amber Perforated: Unit Dose Blister
203-11-30	30-Dose Medium Amber Perforated: Unit Dose Blister
203-16-30	30-Dose Large Amber Perforated: Unit Dose Blister
203-13XL-30	30-Dose XL Amber Perforated: Unit Dose Blister

Refer to page 37 for unit dose blister sizes

Unit Dose Foil Labeling System

Omniceil's unit dose foil labeling system meets the unique needs of the long-term care pharmacy by producing high quality bar code scannable label sheets quickly and efficiently. This standalone system prints foil lidding containing all pertinent drug information and barcodes.

- Accommodate diverse packaging needs including unit-dose box, short-cycle dispensing, reclaimable blister cards, eKits and automated dispensing cabinets
- Reduce waste by pre-packing expensive medications into reclaimable blister cards (as allowed by state regulations)
- Track log numbers and expiration dates using barcode technology, with option of printable daily production report

Included

- Tharo H627 – 203 dpi thermal transfer printer
- Rotary cutter
- Labeling software program with database and report generator
- Barcode scanner with cable and stand
- Communication cables

Usage

This high-speed durable printer prints up to 18 sheets of Omnicell foil (576 unit doses) per minute. The printer automatically cuts the foil to size, making it ready for direct application to the unit dose blister. The Unit Dose Foil Labeling System can be used standalone or in conjunction with Omnicell automation.



Unit Dose with printed barcode



Tharo H627 thermal transfer printer

Reach out to your Omnicell Sales Representative for more information.

MultiMed Blister Cards



SureMed by Omnicell MultiMed packaging enables clear and easy packaging and labeling of multiple medications in a blister card format. Our versatile solutions support MultiMed operations of any size, scale and patient type.

Cold Seal & Heat Seal Accessories

Cold Seal Foam & Sealing Templates



Item 584-64-MP
7 Day/28 Dose
Sealing Template for
MultiMed. Included
in 301-25-PACK and
301-56-PACK



Item 657-31
31 Cavity Sealing
Foam Template



Item 584-31
28 Cavity MultiMed
SureMed Standard
Sealing Template



Item 584-30
28 Cavity MultiMed
SureMed Plus Sealing
Template



Item 584-33
28 Cavity MultiMed
SureMed XL Sealing
Template



Item 584-34
30 Cavity MultiMed
SureMed 30 Sealing
Template



Item 584-67-MP
Weekly 14 Cavity
Plastic Sealing Tray

Non-Perforated MultiMed Heat Seal Paddles



Item 651-41A
28 Cavity Tri-Fold
Paddle: Standard



Item 651-41
28 Cavity Tri-Fold
Paddle: Deeper

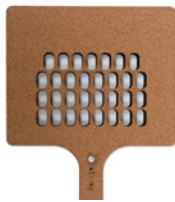

Item 651-42
31 Cavity Tri-Fold
Paddle



Item 651-38
31 Cavity Bi-Fold
Paddle

Perforated MultiMed Heat Seal Paddles



Item 651-30
Weekly 28 Cavity
Tri-Fold Paddle: XL

These non-perforated tri-fold cards offer pharmacies a high-quality finished product to provide to their client base.

Item 301-25-PACK

Weekly 7x4 MultiMed Timepass Cold Seal Card with Standard Blister & Sealing Tray

301-25-PACK includes: 250 Cards | 250 Blisters | 1 Sealing Tray



*Roller not included in 301-25-PACK

Recommended Accessories

Quantity: 1

Item Number	Description
660-00	Cold Seal Roller

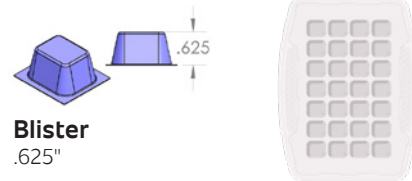

Blister
.625"

Item 301-56-PACK

Weekly 7x4 MultiMed Timepass Cold Seal Card with Deeper Blister & Sealing Tray

301-56-PACK includes: 250 Cards | 250 Blisters | 1 Sealing Tray



*Roller not included in 301-56-PACK

Recommended Accessories

Quantity: 1

Item Number	Description
660-00	Cold Seal Roller

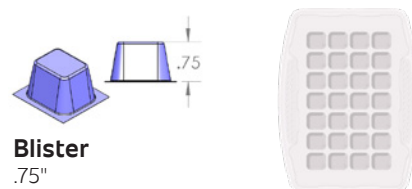

Blister
.75"

Item 301-17

31-Day Countdown Tri-Fold Cold Seal Card

Quantity: 250/Box



Coordinating Blisters

Quantity: 250/Box

Item Number	Description
204-10	31 Cavity MultiMed Blister

Recommended Accessories

Quantity: 1

Item Number	Description
657-31	31 Cavity Sealing Foam Template
660-00	Cold Seal Roller

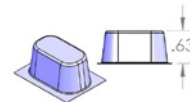

Blister
.63"

Item 301-10

31-Day Countdown Tri-Fold Heat Seal Card

Quantity: 250/Box

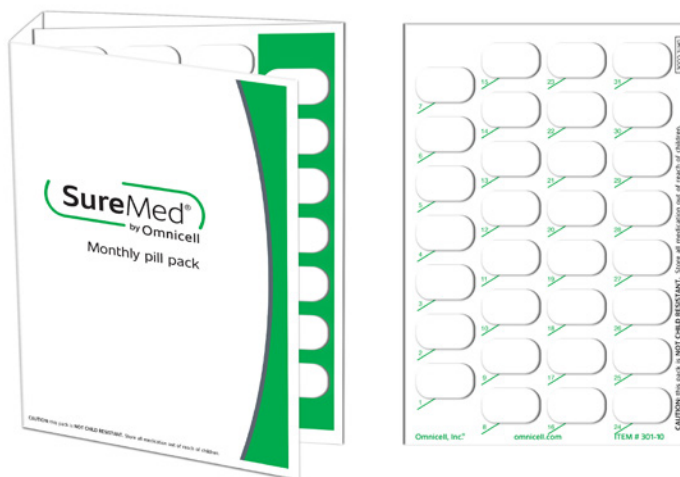

Coordinating Blisters

Quantity: 250/Box

Item Number	Description
204-10	31 Cavity MultiMed Blister

Recommended Accessories

Quantity: 1

Item Number	Description
651-42	31 Cavity Tri-Fold Paddle

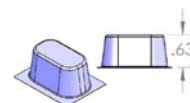

Blister
.63"

Item 301-11

31-Day Calendar Tri-Fold
Heat Seal Card

Quantity: 250/Box

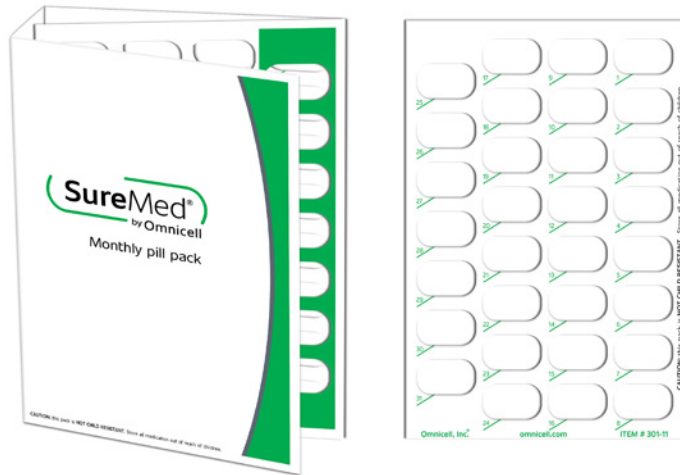

Coordinating Blisters

Quantity: 250/Box

Item Number	Description
204-10	31 Cavity MultiMed Blister

Recommended Accessories

Quantity: 1

Item Number	Description
651-42	31 Cavity Tri-Fold Paddle

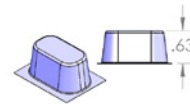

Blister
.63"

Item 301-21

Weekly 7x4 MultiMed Timepass
Heat Seal Card

Quantity: 250/Box

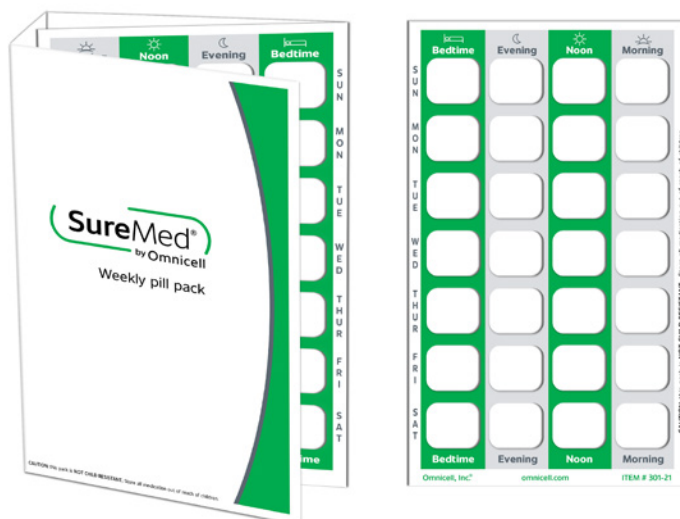

Coordinating Blisters

Quantity: 250/Box

Item Number	Description
200-46	28 Cavity MultiMed Standard Blister
200-56*	28 Cavity MultiMed Deeper Blister
203-46	28 Cavity MultiMed Standard Amber Blister

Recommended Accessories

Quantity: 1

Item Number	Description
651-41A	28 Cavity Tri-Fold Paddle: Standard
651-41*	28 Cavity Tri-Fold Paddle: Deeper

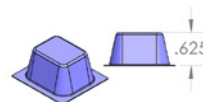

Blister
.625"

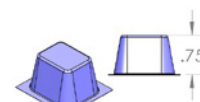

Deeper Blister
.75"

*Deeper Blister requires Deeper Paddle

Item 300-17

31-Day Bi-Fold Heat Seal Card

Quantity: 500/Box

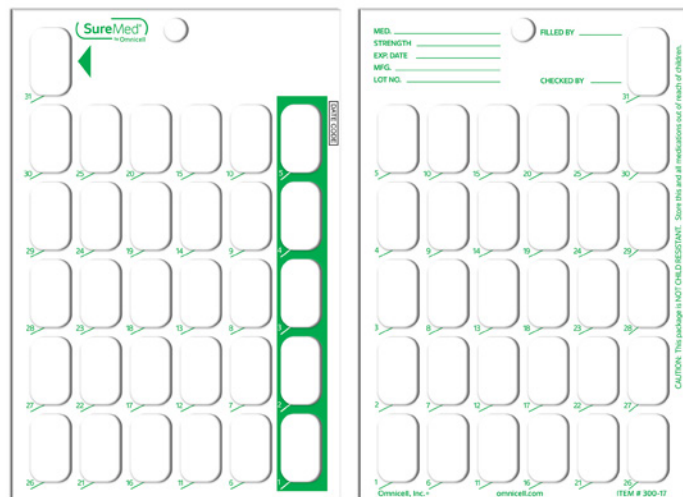

Coordinating Blisters

Quantity: 1000/Box

Item Number	Description
200-19	31 Cavity Bi-Fold Blister

Recommended Accessories

Quantity: 1

Item Number	Description
651-38	31 Cavity Bi-Fold Paddle

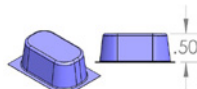

Blister
.50"

Item 301-53

Weekly 7x2 Tri-Fold MultiMed Timepass Cold Seal Card

Quantity: 250/Box



Coordinating Blisters

Quantity: 250/Box

Item Number	Description
200-53	14 Cavity MultiMed Standard Blister

Recommended Accessories

Quantity: 1

Item Number	Description
584-67-MP	Weekly 14 Cavity Plastic Sealing Tray
660-00	Cold Seal Roller

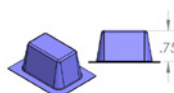

Blister
.75"

Perforated cards allow end users to detach each time-of-day blister from the larger card. These cards were designed to work with Omnicell's Guided Packing software as well as various MultiMed Automation solutions in the market. See page 77 for more information.

Item 300-96

7x4 Bi-Fold Cold Seal Perforated Card

Quantity: 250/Box



Coordinating Blisters

Quantity: 250/Box

Item Number	Description
206-37	28 Cavity Perforated MultiMed Blister (SureMed Standard)

Recommended Accessories

Quantity: 1

Item Number	Description
584-31	28 Cavity MultiMed SureMed Standard Sealing Template
660-00	Cold Seal Roller
A-0590D	Epson Workforce Pro EP-C7000
Guided Packing Subscription	Refer to page 77

Item 300-96GLB

7x4 Bi-Fold Cold Seal Perforated Card: Co-Branded

Quantity: 250/Box



Coordinating Blisters

Quantity: 250/Box

Item Number	Description
206-37	28 Cavity Perforated MultiMed Blister (SureMed Standard)

Recommended Accessories

Quantity: 1

Item Number	Description
584-31	28 Cavity MultiMed SureMed Standard Sealing Template
660-00	Cold Seal Roller
A-0590D	Epson Workforce Pro EP-C7000
Guided Packing Subscription	Refer to page 77

Item 301-96

7x4 Bi-Fold Large Cold Seal
Perforated Card

Quantity: 250/Box



Coordinating Blisters

Quantity: 250/Box

Item Number	Description
206-39	28 Cavity Perforated MultiMed Blister (SureMed Plus)

Recommended Accessories

Quantity: 1

Item Number	Description
584-30	28 Cavity MultiMed SureMed Plus Sealing Template
660-00	Cold Seal Roller
A-0590D	Epson Workforce Pro EP-C7000
Guided Packing Subscription	Refer to page 77

Item 301-96GLB

7x4 Bi-Fold Large Cold Seal
Perforated Card: Co-Branded

Quantity: 250/Box



Coordinating Blisters

Quantity: 250/Box

Item Number	Description
206-39	28 Cavity Perforated MultiMed Blister (SureMed Plus)

Recommended Accessories

Quantity: 1

Item Number	Description
584-30	28 Cavity MultiMed SureMed Plus Sealing Template
660-00	Cold Seal Roller
A-0590D	Epson Workforce Pro EP-C7000
Guided Packing Subscription	Refer to page 77

Item 302-96GLB

30-Day Bi-Fold Cold Seal
Perforated Card

Quantity: 250/Box



Coordinating Blisters

Quantity: 250/Box

Item Number	Description
209-30	30 Cavity Perforated MultiMed Blister (SureMed 30)

Recommended Accessories

Quantity: 1

Item Number	Description
584-34	30 Cavity MultiMed SureMed 30 Sealing Template
660-00	Cold Seal Roller
A-0590D	Epson Workforce Pro EP-C7000
Guided Packing Subscription	Refer to page 77

Item 309-96GLB

7x4 Bi-Fold XL Cold Seal
Perforated Card: Co-Branded

Quantity: 250/Box



Coordinating Blisters

Quantity: 250/Box

Item Number	Description
209-39	28 Cavity Perforated MultiMed Blister (SureMed XL)

Recommended Accessories

Quantity: 1

Item Number	Description
584-33	28 Cavity MultiMed SureMed XL Sealing Template
660-00	Cold Seal Roller
B09-00-00-456	Kyocera Ecosys P8060cdn
Guided Packing Subscription	Refer to page 77

Item 303-28L

7x4 11-3/4" DosiPill Label

Quantity: 500/Box

Coordinating Blisters

Quantity: 450/Box

Item Number	Description
290-1-US	DosiPill Blister: XL

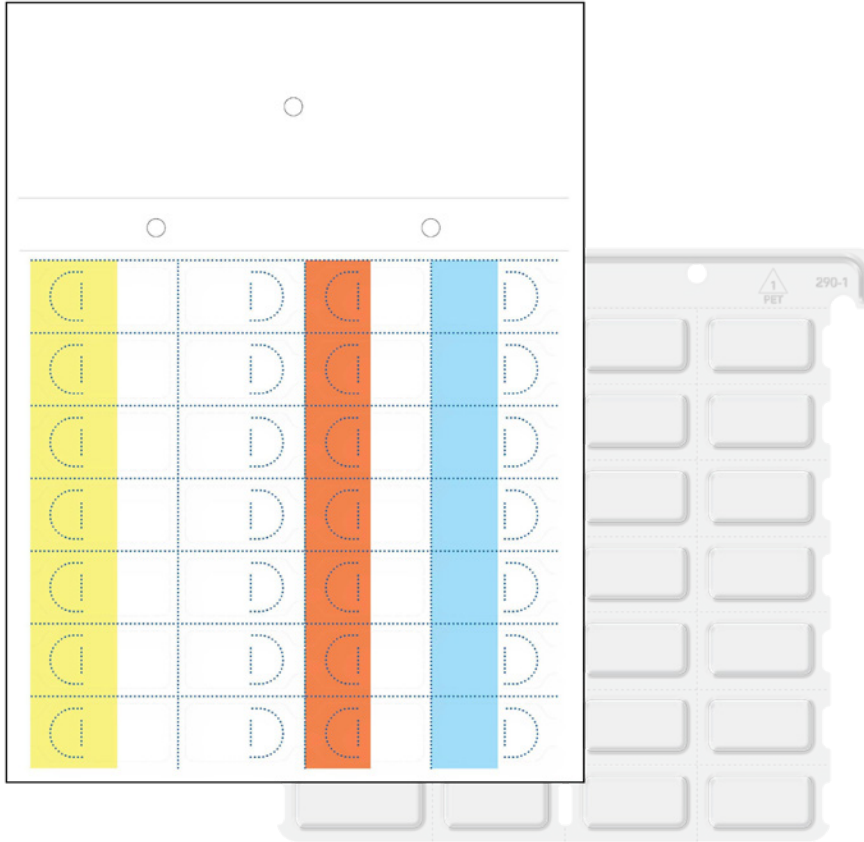

Automation Supported Consumables



Our thoughtfully designed Automation Supported Consumable portfolio enables pharmacies to maximize the potential of automation investments and provide customers with the highest quality consumable products.

Omnicell's AccuFlex and E3 Systems automate the filling, sealing, and labeling of blister cards to streamline pharmacy workflows and improve efficiency. These platforms are supported by a portfolio of barcoded consumables engineered for seamless compatibility and reliable performance across dosing formats.



AccuFlex



Express III (E3)

To learn more about Omnicell's Single Dose Automation solutions, go to page 83 (AccuFlex) and page 84 (E3)

Item 300-06

31-Dose OnDemand Card

Quantity: 500/Box

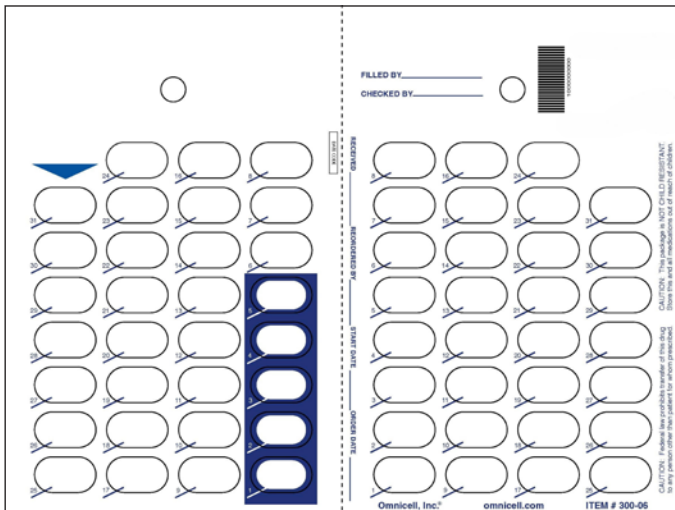

Coordinating Blisters

Quantity: 1,000/Box

Item Number	Description
202-310V	31-Dose Medium OnDemand Blister
202-32	31-Dose Large OnDemand Blister
203-33	31-Dose Large Amber Blister

Refer to page 7 for blister sizes

Item 300-05A

30-Dose OnDemand Card

Quantity: 500/Box

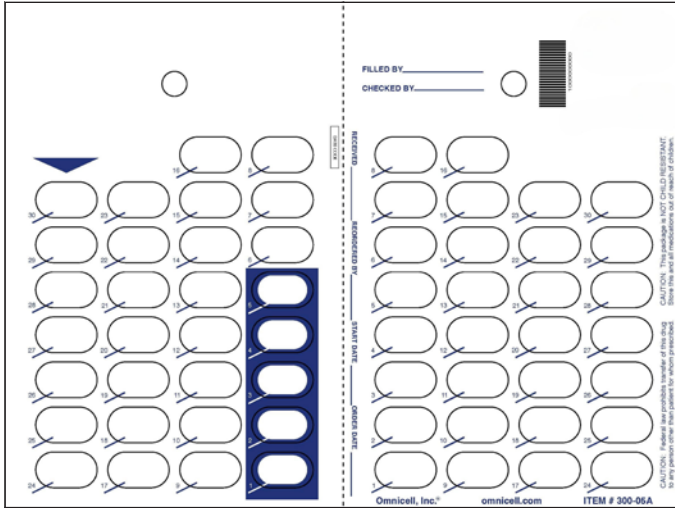

Coordinating Blisters

Quantity: 1,000/Box

Item Number	Description
202-280V	30-Dose Medium OnDemand Blister
202-30	30-Dose Large OnDemand Blister
203-34	30-Dose Large Amber Blister

Refer to page 7 for blister sizes

Item 300-06

31-Dose OnDemand Card

Quantity: 500/Box

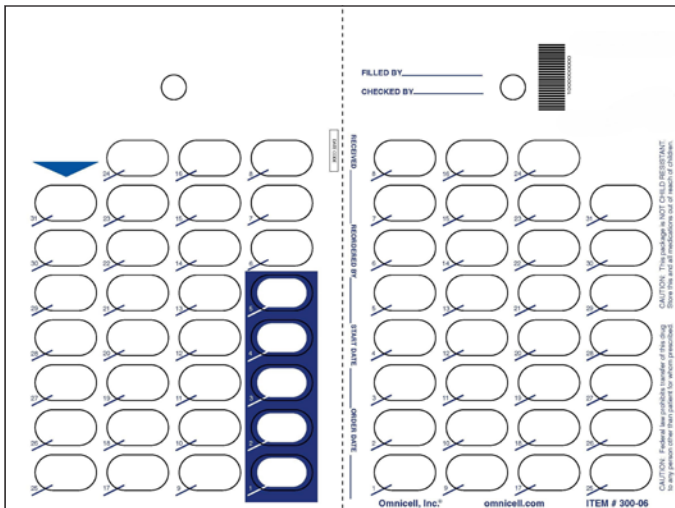

Coordinating Blisters

Quantity: 1,000/Box

Item Number	Description
202-310V	31-Dose Medium OnDemand Blister
202-32	31-Dose Large OnDemand Blister
203-33	31-Dose Large Amber Blister

Refer to page 7 for blister sizes

Item 300-08

31-Dose Calendar OnDemand Card

Quantity: 500/Box

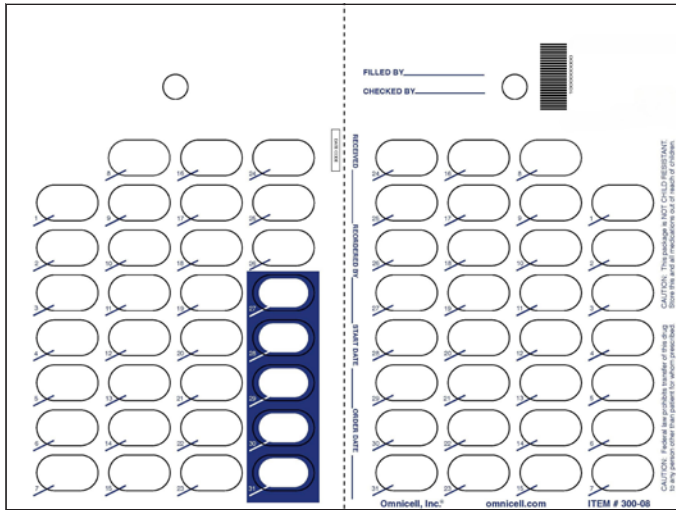

Coordinating Blisters

Quantity: 1,000/Box

Item Number	Description
202-310V	31-Dose Medium OnDemand Blister
202-32	31-Dose Large OnDemand Blister
203-33	31-Dose Large Amber Blister

Refer to page 7 for blister sizes

Item 300-04

30-Dose Select Seal OnDemand Card

Quantity: 500/Box

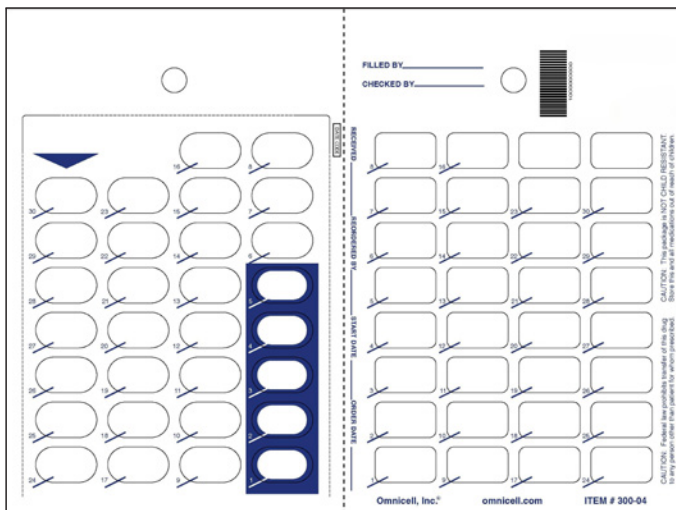

Coordinating Blisters

Quantity: 1,000/Box

Item Number	Description
202-13XL-30	30-Dose Perforated Unit Dose OnDemand Blister
203-13XL-30	30-Dose Perforated Unit Dose Amber Blister

Foil

Quantity: 1,000/Roll

Item Number	Description
680-19	Thermal Transfer Foil: 1-Step for Select Seal Card

Quantity: 2,500/Roll

Item Number	Description
680-19-3	Thermal Transfer Foil: 1-Step for Select Seal/E2/E3

Refer to page 37 for blister sizes

Item 300-02

31-Dose Select Seal OnDemand Card:
3/8" Bottom Bridge

Quantity: 500/Box

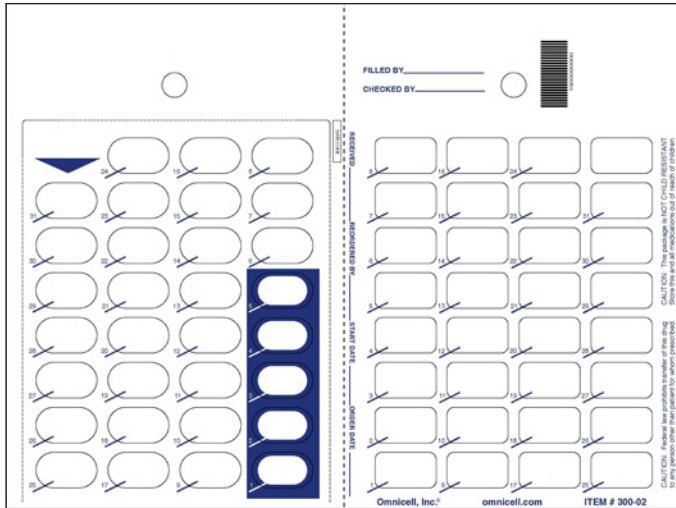

Coordinating Blisters

Quantity: 1,000/Box

Item Number	Description
202-13XL-31	31-Dose Perforated Unit Dose OnDemand Blister

Foil

Quantity: 1,000/Roll

Item Number	Description
680-19	Thermal Transfer Foil: 1-Step for Select Seal Card

Quantity: 2,500/Roll

Item Number	Description
680-19-3	Thermal Transfer Foil: 1-Step for Select Seal/E2/E3

Refer to page 37 for blister sizes

Item 300-03

31-Dose Select Seal OnDemand Card:
5/8" Bottom Bridge

Quantity: 500/Box

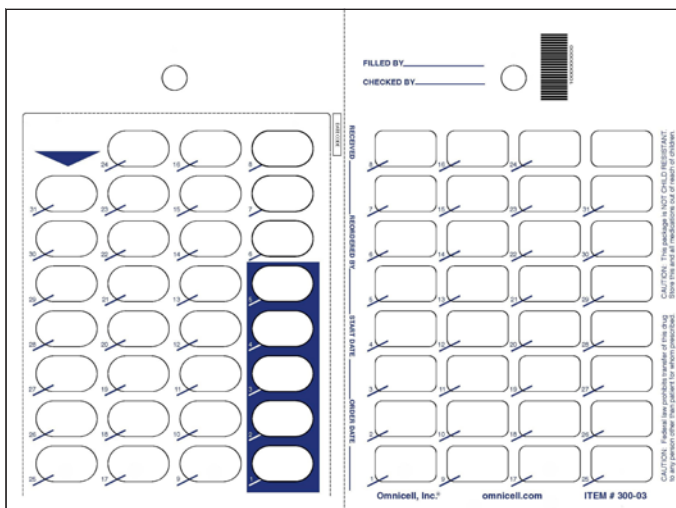

Coordinating Blisters

Quantity: 1,000/Box

Item Number	Description
202-13XL-31	31-Dose Perforated Unit Dose OnDemand Blister

Foil

Quantity: 1,000/Roll

Item Number	Description
680-19	Thermal Transfer Foil: 1-Step for Select Seal Card

Quantity: 2,500/Roll

Item Number	Description
680-19-3	Thermal Transfer Foil: 1-Step for Select Seal/E2/E3

Refer to page 37 for blister sizes

Omniceil's DOSIS Blister Cards are designed specifically for use with the DOSIS L60 in partnership with Manchac. Omnicell's single dose blister cards and lidding designed for DOSIS went through a rigorous testing process to ensure they meet the superior standards our customers have come to expect.



DOSIS L60 Tower

30-Dose DOSIS

30-Dose DOSIS 1-Piece Card

Quantity: 500/Box

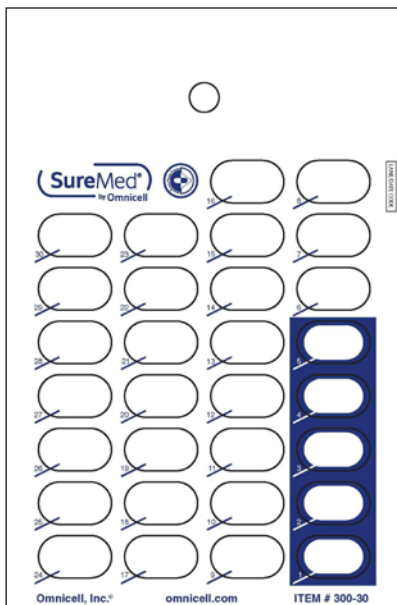

Cards

Item Number	Description
300-30-B30M	30-Dose DOSIS 1-Piece Card: Medium
300-30-B30OV	30-Dose DOSIS 1-Piece Card: Large
300-30-A30OV	30-Dose DOSIS 1-Piece Amber Card: Large

Coordinating Lidding

Quantity: 900/Box (450 lids/roll, 2 rolls/box)

Item Number	Description
L-300-30	30-Dose DOSIS Lidding

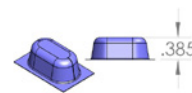

Medium Blister
.385"

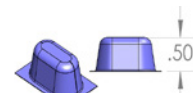

Large Blister
.50"

31-Dose DOSIS

31-Dose DOSIS 1-Piece Card

Quantity: 500/Box

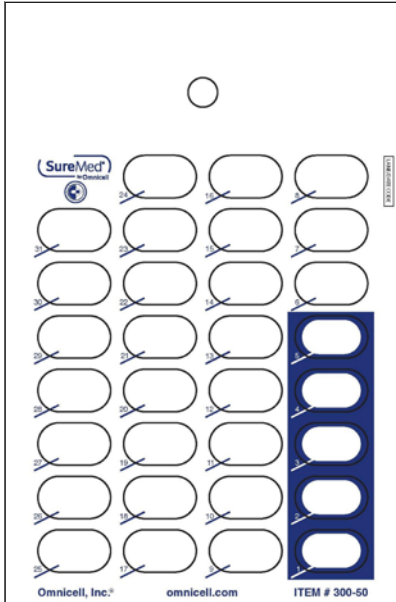

Cards

Item Number	Description
300-50-B31M	31-Dose DOSIS 1-Piece Card: Medium
300-50-B31OV	31-Dose DOSIS 1-Piece Card: Large
300-50-A31OV	31-Dose DOSIS 1-Piece Amber Card: Large

Coordinating Lidding

Quantity: 900/Box (450 lids/roll, 2 rolls/box)

Item Number	Description
L-300-50	31-Dose DOSIS Lidding



Medium Blister
.385"



Large Blister
.50"

31-Dose Calendar DOSIS

31-Dose Calendar DOSIS 1-Piece Card

Quantity: 500/Box

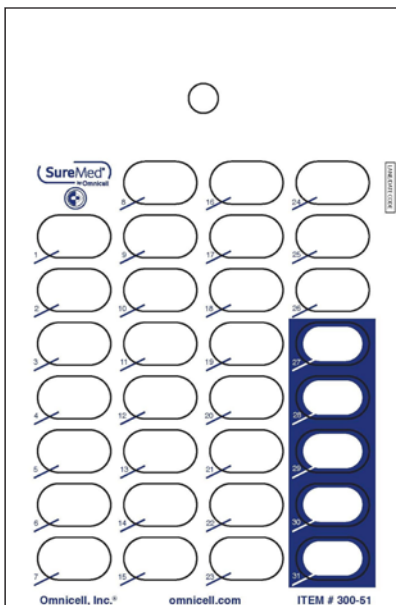

Cards

Item Number	Description
300-51-B31#10V	31-Dose Calendar DOSIS 1-Piece Card

Coordinating Lidding

Quantity: 900/Box (450 lids/roll, 2 rolls/box)

Item Number	Description
L-300-51	31-Dose Calendar DOSIS Lidding



Medium Blister
.385"



Large Blister
.50"

DOSIS Labels

Reorder Tab

Quantity: 4,000/Box

Labels

Item Number	Description
L-300-52	4" x 2" with Reorder Tab: No Perforation Between Labels
L-300-53	4" x 2" with Reorder Tab: Perforation Between Labels



DOSIS Labels

No Reorder Tab

Quantity: 4,000/Box

Labels

Item Number	Description
L-300-54	4" x 2" No Reorder Tab: No Perforation Between Labels
L-300-55	4" x 2" No Reorder Tab: Perforation Between Labels

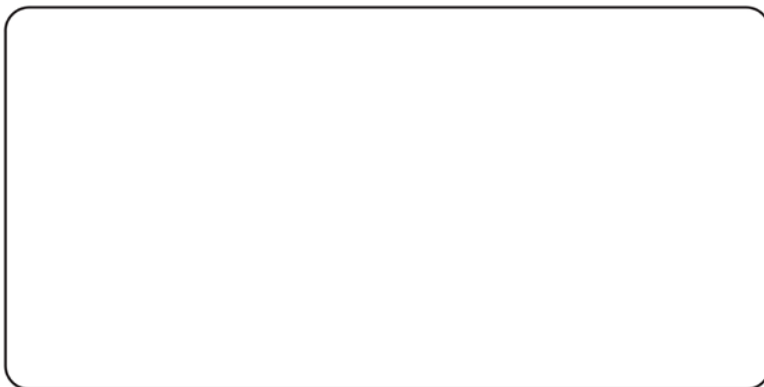

*Labels printed at actual size; see page 89 for details.

DOSIS 4x Time Pass Labels

Reorder Tab

Quantity: 4,000/Box

Labels

Item Number	Description
L-300-56	4" x 2" with Reorder Tab: No Perforation Between Labels
L-300-57	4" x 2" with Reorder Tab: Perforation Between Labels

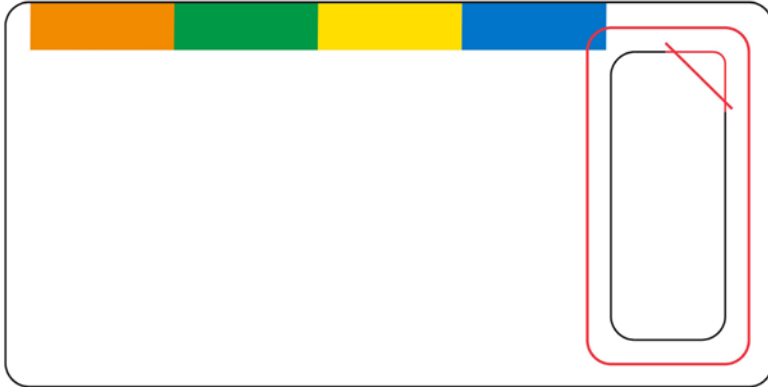

DOSIS 5x Time Pass Labels

Reorder Tab

Quantity: 4,000/Box

Labels

Item Number	Description
L-300-58	4" x 2" with Reorder Tab: No Perforation Between Labels
L-300-59	4" x 2" with Reorder Tab: Perforation Between Labels



*Labels printed at actual size; see page 89 for details.

Item 301-96

7x4 Bi-Fold Large Cold Seal
Perforated Card

Quantity: 250/Box



Coordinating Blisters

Quantity: 250/Box

Item Number	Description
206-39	28 Cavity Perforated MultiMed Blister (SureMed Plus)

Automation Supported: BlistAssist, Synmed ULTRA, Synmed XF, RapidCardRX by RXSafe, VBM, Omnicell Guided Packing

Item 301-96GLB

7x4 Bi-Fold Large Cold Seal
Perforated Card: Co-Branded

Quantity: 250/Box



Coordinating Blisters

Quantity: 250/Box

Item Number	Description
206-39	28 Cavity Perforated MultiMed Blister (SureMed Plus)

Automation Supported: Synmed ULTRA, Synmed XF, RapidCardRX by RXSafe, VBM, Omnicell Guided Packing

Reach out to your Omnicell Sales Representative for a full list of automation partners.

Item 300-96

7x4 Bi-Fold Cold Seal
Perforated Card

Quantity: 250/Box



Coordinating Blisters

Quantity: 250/Box

Item Number	Description
206-37	28 Cavity Perforated MultiMed Blister (SureMed Standard)

Automation Supported:

BlistAssist, RapidCardRX by RXSafe,
Omnicell Guided Packing

Item 300-96GLB

7x4 Bi-Fold Cold Seal
Perforated Card: Co-Branded

Quantity: 250/Box

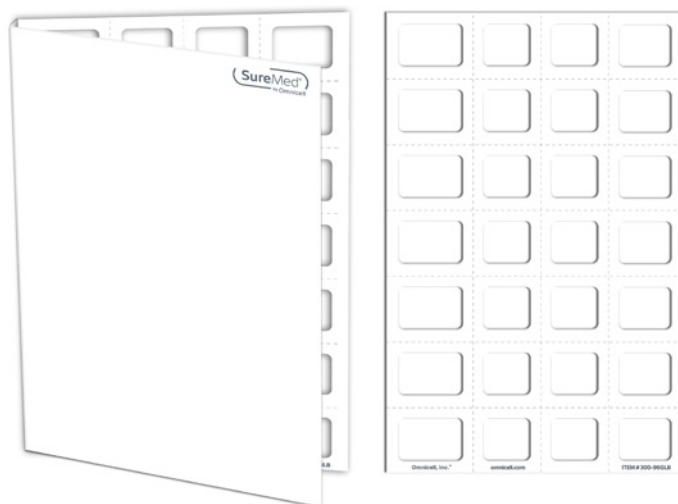

Coordinating Blisters

Quantity: 250/Box

Item Number	Description
206-37	28 Cavity Perforated MultiMed Blister (SureMed Standard)

Automation Supported:

BlistAssist, RapidCardRX by RXSafe,
Omnicell Guided Packing

Reach out to your Omnicell Sales Representative for a full list of automation partners.

Item 303-28L

7x4 11-3/4" DosiPill Label

Quantity: 500/Box

Coordinating Blisters

Quantity: 450/Box

Item Number	Description
290-1-US	DosiPill Blister: XL

Automation Supported: BlistAssist, Synmed Ultra, Synmed XF, VBM, RapidCardRX by RXSafe

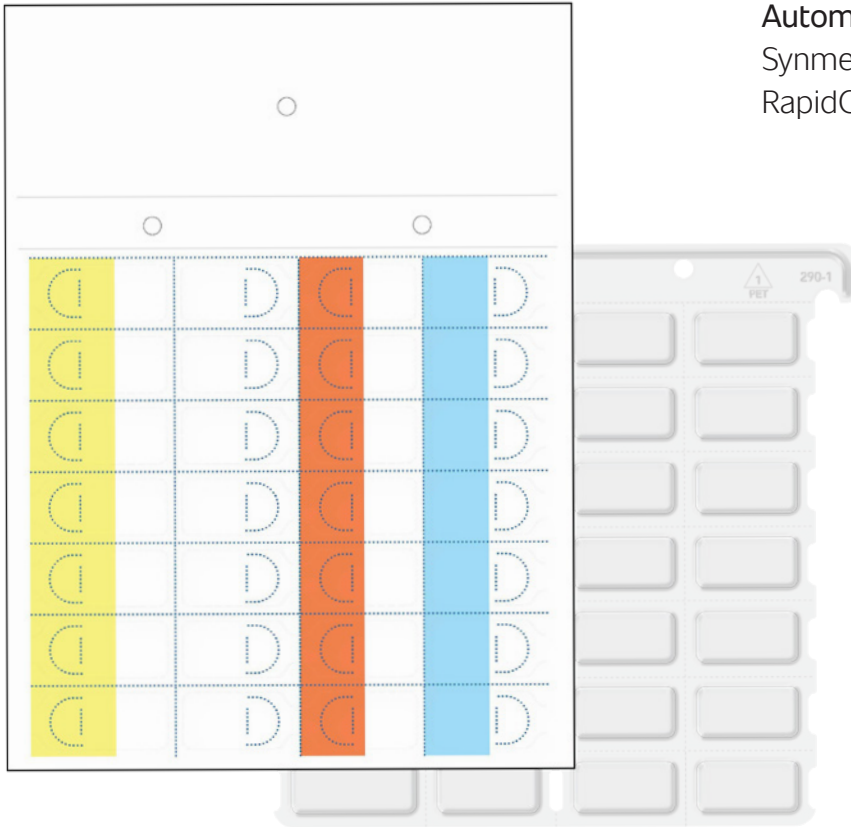

Reach out to your Omnicell Sales Representative for a full list of automation partners.

Medication Packaging Equipment



With more than 30+ years of dependable products, Omnicell's Medication Packaging Equipment solutions are the backbone of institutional, LTC, and hybrid pharmacies.

Autogen™

The Omnicell Autogen Automated Heat Sealer sets the industry standard for automated heat sealers, helping your pharmacy enhance operational efficiency without requiring an air compressor. With the Autogen Automated Heat Sealer you can seal SureMed™ by Omnicell heat seal blister cards in under four seconds. Simply plug it into any standard 110V outlet to begin using its 500 pounds of sealing force.

- Whisper-quiet operation
- Safe two-handed operation to activate sealing mechanism
- Eliminates blister card pressure variants associated with manual sealing equipment
- Precision designed for hassle-free, reliable operation
- Enhanced airflow design creates lower heated-air emissions
- Rugged stainless steel and anodized aluminum construction allows for easy cleaning



SureSeal™

The Omnicell SureSeal Manual Heat Sealer is a programmable, manual sealer for pharmacies looking for an economic way to begin offering SureMed by Omnicell heat seal medication blister cards. The sealer is shipped completely assembled and includes a two-up configured blister card paddle.

- Easy-to-set temperature controls with digital display
- Ergonomic design reduces the physical effort associated with repetitive manual sealing
- Timer and automatic pop-up platen
- Digital pressure indicator
- All settings are preprogrammed



Deblister Machine

The Omnicell Deblistering Machine helps you effortlessly remove medications from blister card packaging, simplifying a once-tedious task. It can be used to deblister a variety of blister card types.

- Small and portable
- Hand-operated
- Deblisters the following dose cards:
30, 31, 32, 60, 62, 90
- Heavy-duty design
- Saves time and money



KirbyLester KL1v

The KL1v is designed for simplicity and accuracy, ensuring precise prescription filling and inventory management for pharmacies. Its compact design and easy set up make it ideal for pharmacies looking to reduce errors and optimize workflows.

- Use for fast inventory counting of bulk tablets and capsules
- Counting speed up to 15 tablets per second
- Compact design
- Counts almost any tablet or capsule without calibration, maintains absolute accuracy
- Special mode for odd-shaped pills and gel caps
- Standalone design, needs no interfacing or IT set up



Medication Packaging Software

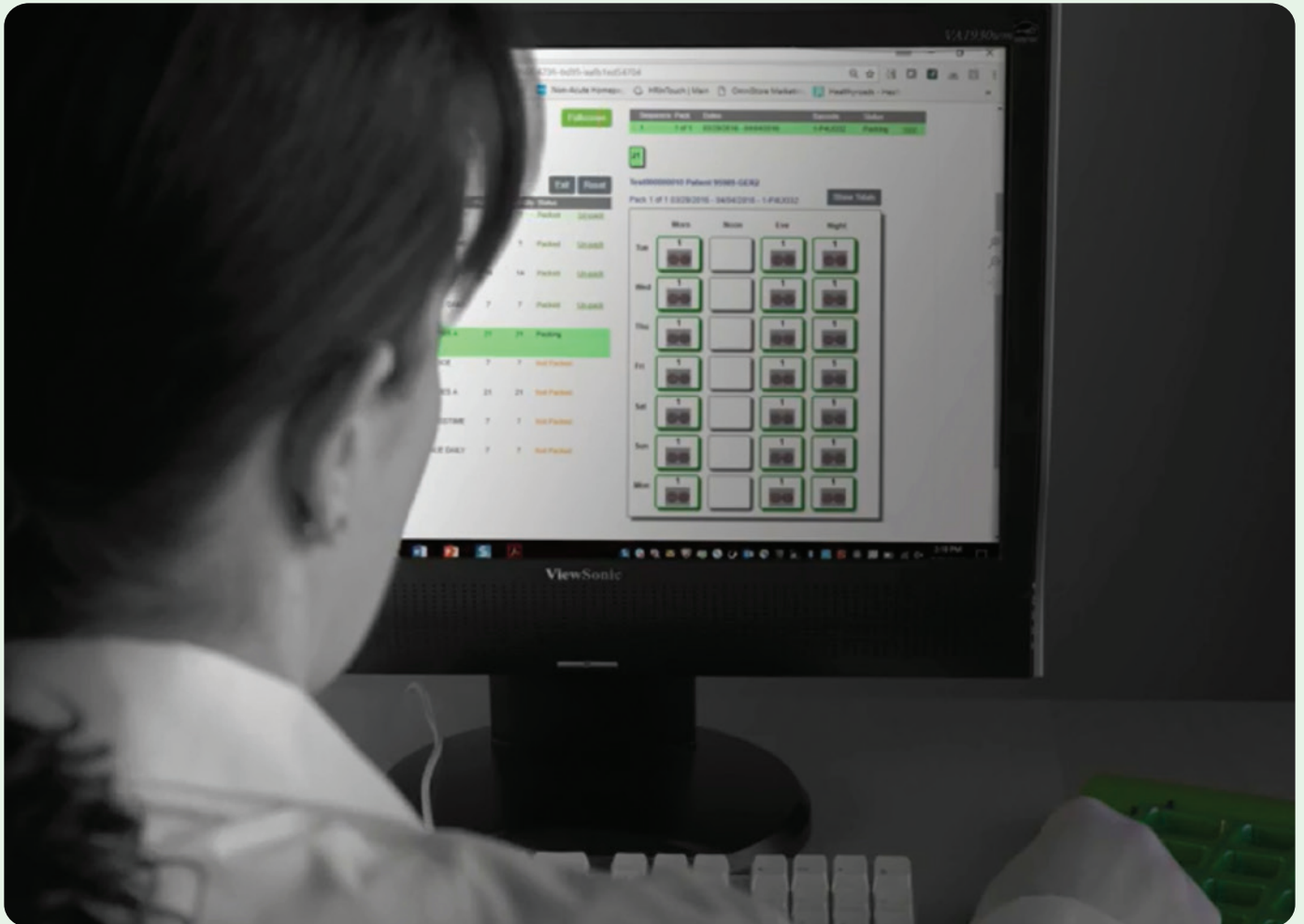

Omniceil's Guided Packing Software solution allows pharmacies to provide differentiated MultiMed adherence packaging services quickly and seamlessly.

Improved Workflow

Guided Packing web-based software allows pharmacies to improve SureMed MultiMed blister card fill throughput with one-step labeling and elimination of double data entry.

Key Features

- Seamlessly integrates with:
 - Pharmacy Information System allowing you to generate a patient-specific label
 - Drug databases, enabling NDC substitutions and inclusion of OTCs
 - EMAR barcode technology
- Configure your SureMed cards using the Guided Packing card customization and labeling options

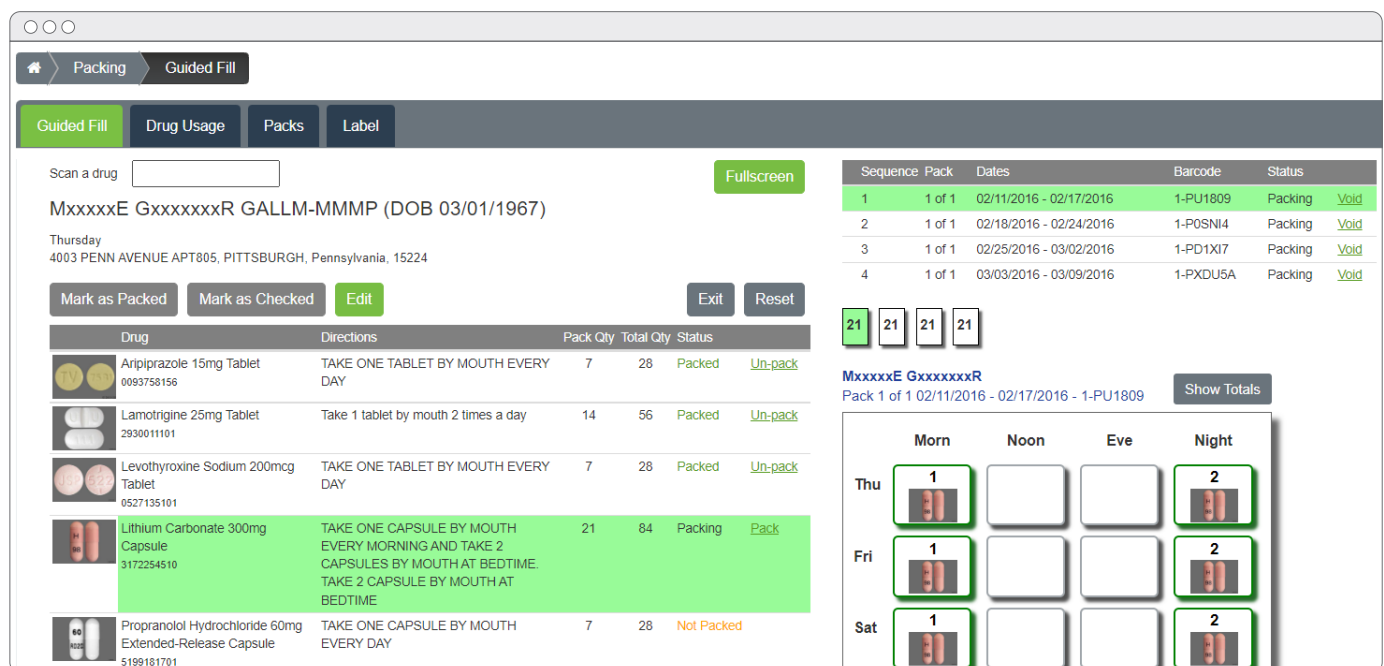

Guided Packing fill screen

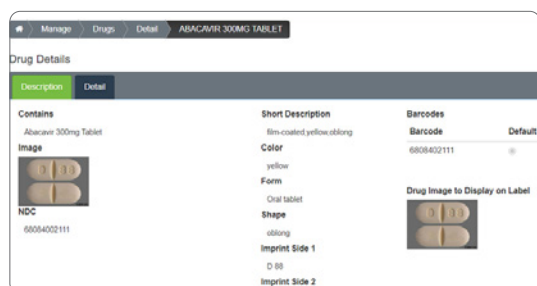

Drug description details window

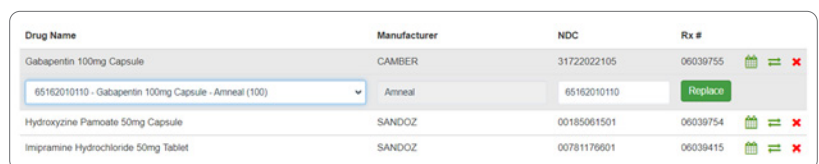

Drug substitutes easily identified

Medication Packaging Automation



Omnicell's portfolio of medication packaging automation solutions help pharmacies package medications accurately and efficiently, supporting inventory optimization and encouraging better patient medication adherence.

MTS-350 Semi-Automated Filler and Sealer

Gain operational efficiency by optimizing your pre-pack workflow. The Omnicell® MTS-350™ is a flexible, easy-to-use filler and sealer capable of filling most oral medications into a variety of single dose blister card packaging. By enabling your pharmacy technicians to package more than 240 cards per hour, the MTS-350 helps you achieve significant operational efficiency within your pre-pack operation.

Features

- Package up to 10 times faster than by hand
- Fill a wide range of medications and packaging styles
- Use minimal operator motion
- Provide consistent, quality sealing with temperature and time controls
- Eliminate blister card pressure variant using robust automated sealing station

Benefits

- Motorized tablet filling system with adjustable speed and easy-to-change brushes
- Tool-less filling system change-over
- Seal station automatically opens when the cycle is complete
- Easy-to-read digital temperature controller
- Stainless steel and anodized aluminum construction allows for easy cleaning



Site Requirements

Dimensions

33"H x 38"W x 28"D

Weight: 110lbs

Air Requirements

Compressor Power minimum 1 HP; Compressed Air 90-100 PSI, Air Flow .5 SCFM, Reserve Tank 15 Gallon

Electrical Requirements

220-240 VAC 50/60 Hz, 10 Am max,
Supplied country-specific power cord

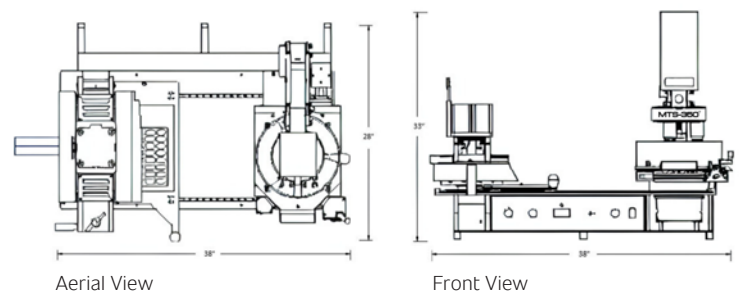

Omnicell's Desktop Label Applicator (DLA) applies labels immediately after the packing process, making it an ideal addition to the MTS-350 for completing your pre-packing operations. Learn more about the DLA on page 125

MTS-500 Semi-Automated Filler and Sealer

Improve packaging efficiency in higher-volume operations. Designed to streamline packaging for Correctional and LTC Pharmacies, the MTS-500™ Semi-Automated Filler and Sealer is capable of producing approximately 850 completed single dose medication blister cards per hour.* That's up to 34 times faster than packaging by hand, creating greater efficiency for your pharmacy. All settings are preprogrammed, making it simple to operate.

Features

- Motorized medication filling system with adjustable speed and easy-to-change brushes
- Tool-less changeover of the filling system
- Easy-to-read digital temperature controller
- Stainless steel and anodized aluminum construction allows for easy cleaning

Benefits

- Improves labor efficiency through high-speed packaging
- Simplifies packaging of high-volume medications in single dose cards
- Automates pre-pack labeling and barcoding
- Increases flexibility with plate-based filling system



Site Requirements

Dimensions

5.5'H x 6.2'W (with printer) x 7.2'D (with printer)
Weight: 1,200lbs

Air Requirements

Compressed Air 100 PSI, 15 SCFM

Electrical Requirements

240 VAC, 1Phase, 20 amps

Adjustable Temperature Range

Max 400°F

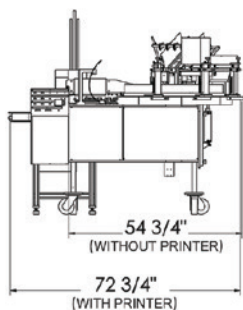

Front View

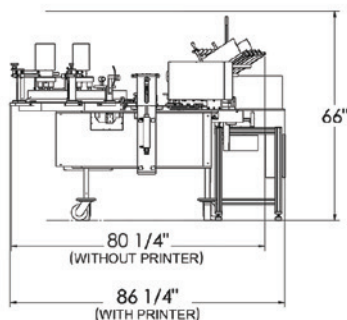

Back View

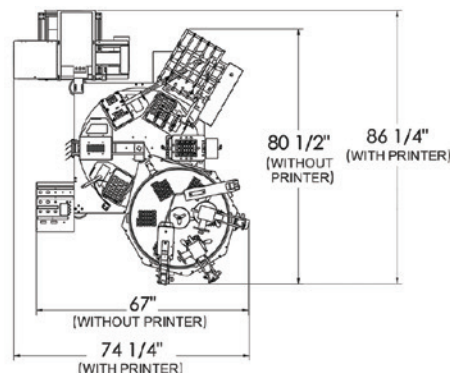

Aerial View
Note: Allow additional 2-foot walkaround each side.

*Max per hour is one technician filling the same drug without medication changes with optimal conditions.

AccuFlex Single Dose Automation

Flexible patient-specific and pre-pack automation. The Omnicell AccuFlex® accurately fills and labels single dose packaging based on incoming prescriptions or pre-pack orders, improving operational efficiency and reducing inventory and labor costs. This high-speed packaging technology comes with software, reports, formulary management, inventory management, custom labeling and foil formatting, installation, and training.

Solution Benefits

- Fills and labels any quantity based on calendar, cycle, or pre-pack
- Throughput of 3.5 filled, sealed, and labeled cards per minute
- Can enable PV2 exemption to maximize workflow and labor efficiency
- Patient-specific blister card filling and labeling

Features

- Interfaced with your Pharmacy Information System
- Automated barcode verification and tracking
- Cassette inventory tracking
- Detailed and custom reports



Site Requirements

Dimensions

8'H x 11.8'W x 12'D

Packager clearance space for service: 15' x 15'

Network Connection Requirements

1 between machine and facility

1 for workstation

1 for server

1 for network printer (optional)

Air Requirements

15 CFM at 100 PSI. Minimum supply of 60 gallons and an air dryer

Electrical Requirements

Packager: 220/240 VAC at 60-amp, single-phase power with disconnect box

Ingress Requirements

Once unloaded, the AF3 and components will require a pathways of 96"H x 64"W to move the system to its location

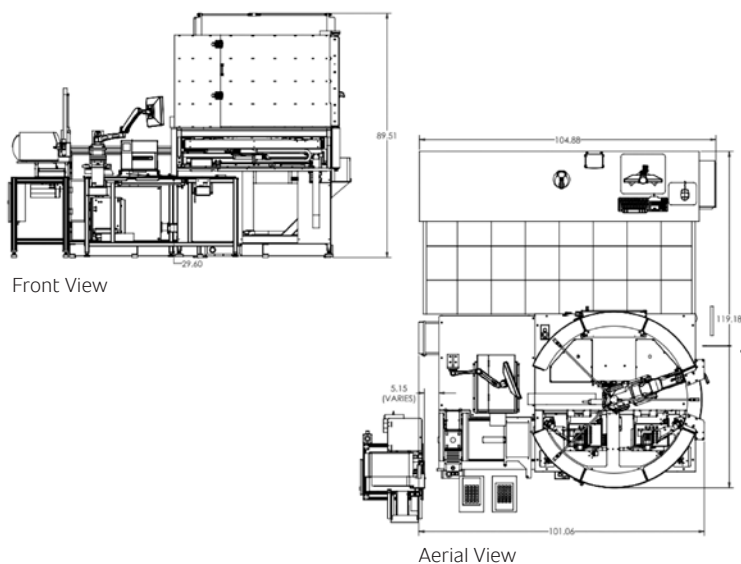

E3 Single Dose Automation

Accelerate single dose blister card fulfillment. Imagine having a faster way to fill single dose blister cards, so you have more time for clinical work that helps patients. With a throughput of 10 cards per minute, Omnicell Express III (E3) Single Dose Automation is the fastest fully automated solution for LTC pharmacies and their customers. The time savings from the Omnicell E3 can help you grow your pharmacy business without adding personnel. You can increase profits by decreasing operational expenses and driving down cost per script associated with filling, sealing, labeling, and verifying blister cards.

Solution Benefits

- Maximize workflow
- Improve pharmacy productivity
- Increase profitability
- Scale efficiently
- Can enable PV2 exemption to maximize workflow and labor efficiency

Features

- Throughput of 10 cards per minute
- 374 cassette locations
- Customized label and foil
- Automated barcode verification and tracking
- Detailed and custom reports available
- Multiple workstations to improve efficiency by separating tasks



Site Requirements

Dimensions

9'H x 20'W x 12.8'D

Total Space Requirements: 20' x 30'

Network Requirements

1 Network connection between machine and facility LAN for data transmission

Minimum of three Gigabit network drops:

1 for E3

1 for workstation (within the work area of the E3)

1 for Server

Air Requirements

27 CFM at 90 PSI (140 PSI max)

Electrical Requirements

Packager 220/240 VAC at 60-amp, single phase

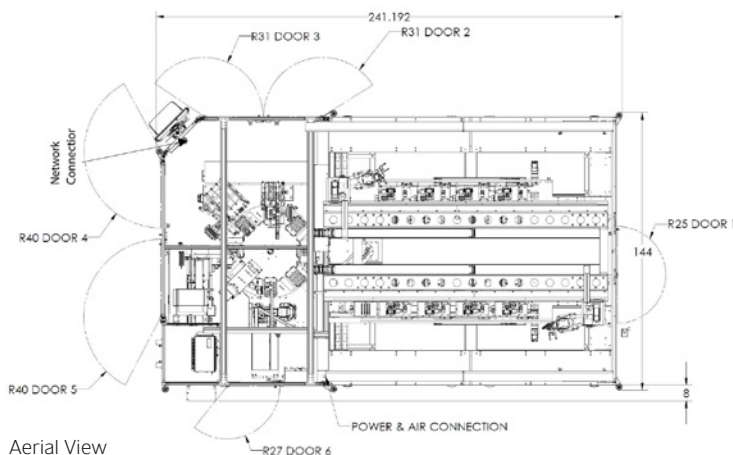

Automated Dispensing Cabinets



The award-winning XT Automated Dispensing System is at the center of Omnicell's portfolio of automation, intelligence, and technology-enabled services, helping your clinicians reallocate time to higher-value work.

XT Automated Dispensing Cabinet

Achieve smarter and safer medication management for non-acute and alternate site care settings with Omnicell's award-winning XT Automated Dispensing Cabinet System.

- Highest capacity on the market
- Metal locking lid drawers for security and safety
- Simple user workflows for improved efficiency
- A flexible and scalable design to adapt to changing medication needs

For more information about Omnicell's XT Automated Dispensing Systems, reach out to MAInsideSales@Omnicell.com.



Printing & Labeling Solutions



Omniceil delivers high-quality prescription labels and custom printing solutions that streamline pharmacy workflows and ensure accuracy and efficiency with every prescription.

**Label images in the printed catalog are shown at actual size, making it easy to compare options. For exact measurements, please check the size specifications printed next to each label, as digital versions may not display labels to scale.*

Item L-TRX016

Size: 3.5" x 5.063"

Quantity: 350/Roll; 4,200/Box

Material: Direct Thermal

Core: 1.5"

Item L-TRX016-Z

Size: 3.5" x 5.063"

Quantity: 1,000/Roll; 4,000/Box

Material: Direct Thermal

Core: 3"

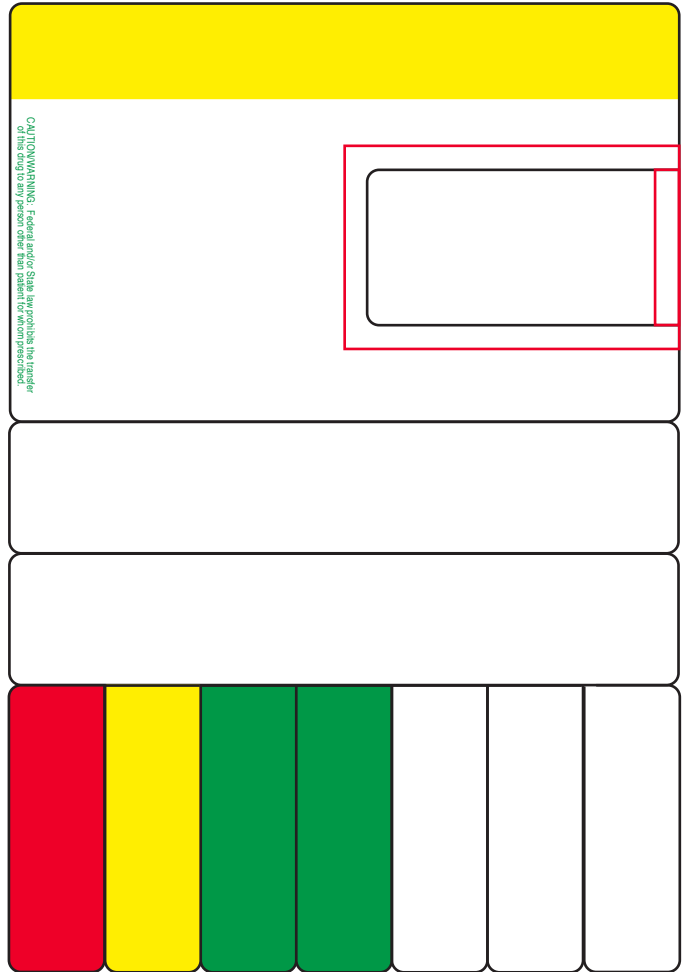

*Labels printed at actual size; see page 89 for details.

Item L-TRX081

Size: 3.5" x 5.063"

Quantity: 500/Roll; 9,000/Box

Material: Direct Thermal

Core: 1.5"

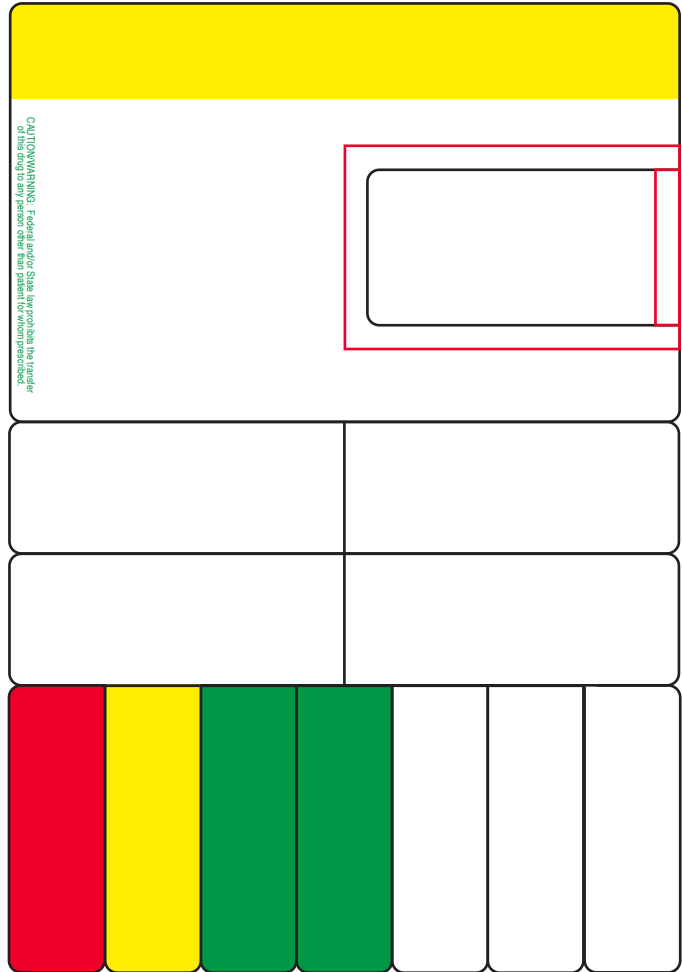

*Labels printed at actual size; see page 89 for details.

Item L-TRX001

Size: 3" x 4.125"

Quantity: 500/Roll; 4,000/Box

Material: Direct Thermal

Core: 1.5"

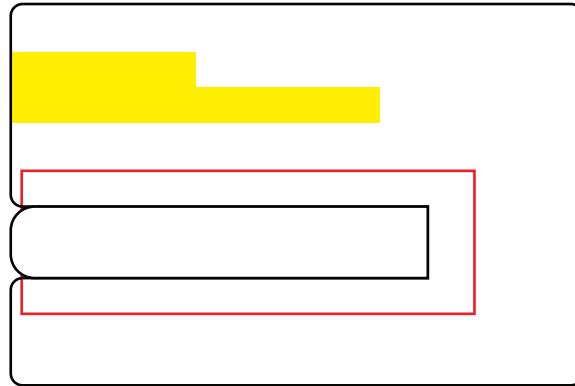

Item L-TRX001-Z

Size: 3" x 4.125"

Quantity: 1,000/Roll; 4,000/Box

Material: Direct Thermal

Core: 3"

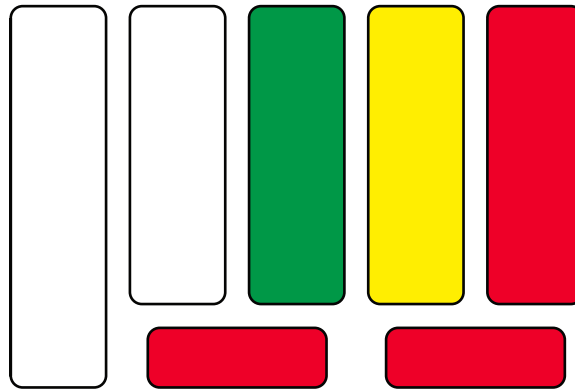

*Labels printed at actual size; see page 89 for details.

Item L-TRX007

Size: 3.75" x 4.375"

Quantity: 500/Roll; 9,000/Box

Material: Direct Thermal

Core: 1.5"

Item L-TRX007-Z

Size: 3.75" x 4.375"

Quantity: 1,250/Roll; 5,000/Box

Material: Direct Thermal

Core: 3"

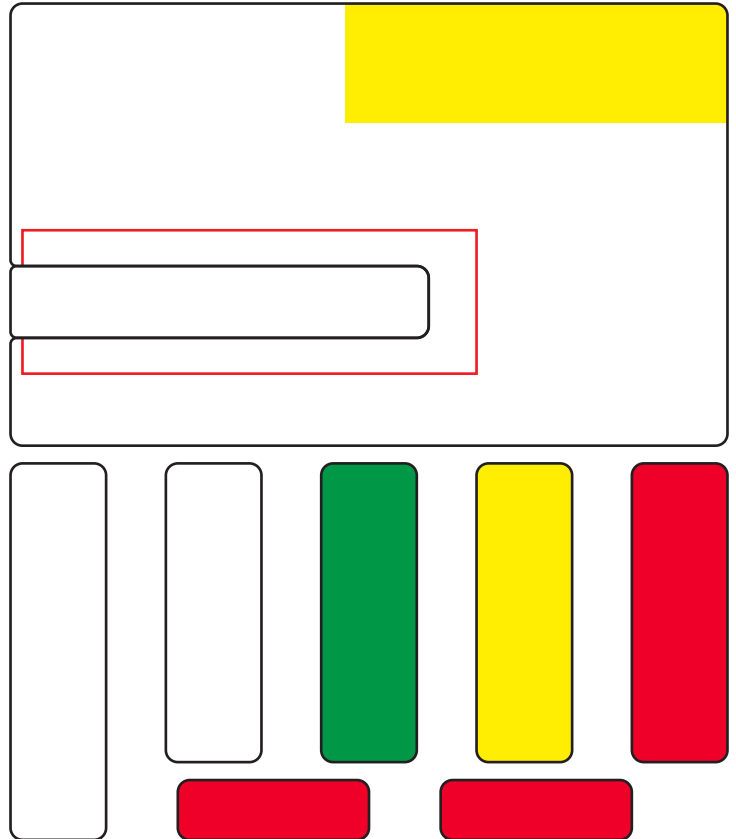

*Labels printed at actual size; see page 89 for details.

Item L-TRX011

Size: 3.688" x 2.75"

Quantity: 500/Roll; 5,000/Box

Material: Direct Thermal

Core: 1.5"

Item L-TRX011-TT

Size: 3.688" x 2.75"

Quantity: 900/Roll; 3,600/Box

Material: Thermal Transfer

Core: 1"

Item L-TRX011-Z

Size: 3.688" x 2.75"

Quantity: 1,000/Roll; 5,000/Box

Material: Direct Thermal

Core: 3"

Item L-TRX011-Z-TT

Size: 3.688" x 2.75"

Quantity: 1,000/Roll; 4,000/Box

Material: Thermal Transfer

Core: 3"

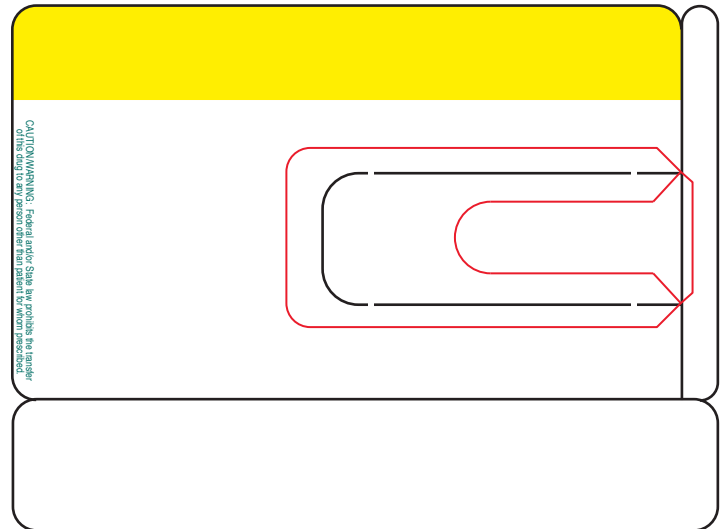

*Labels printed at actual size; see page 89 for details.

Die #657

Size: 4.031" x 7.75"

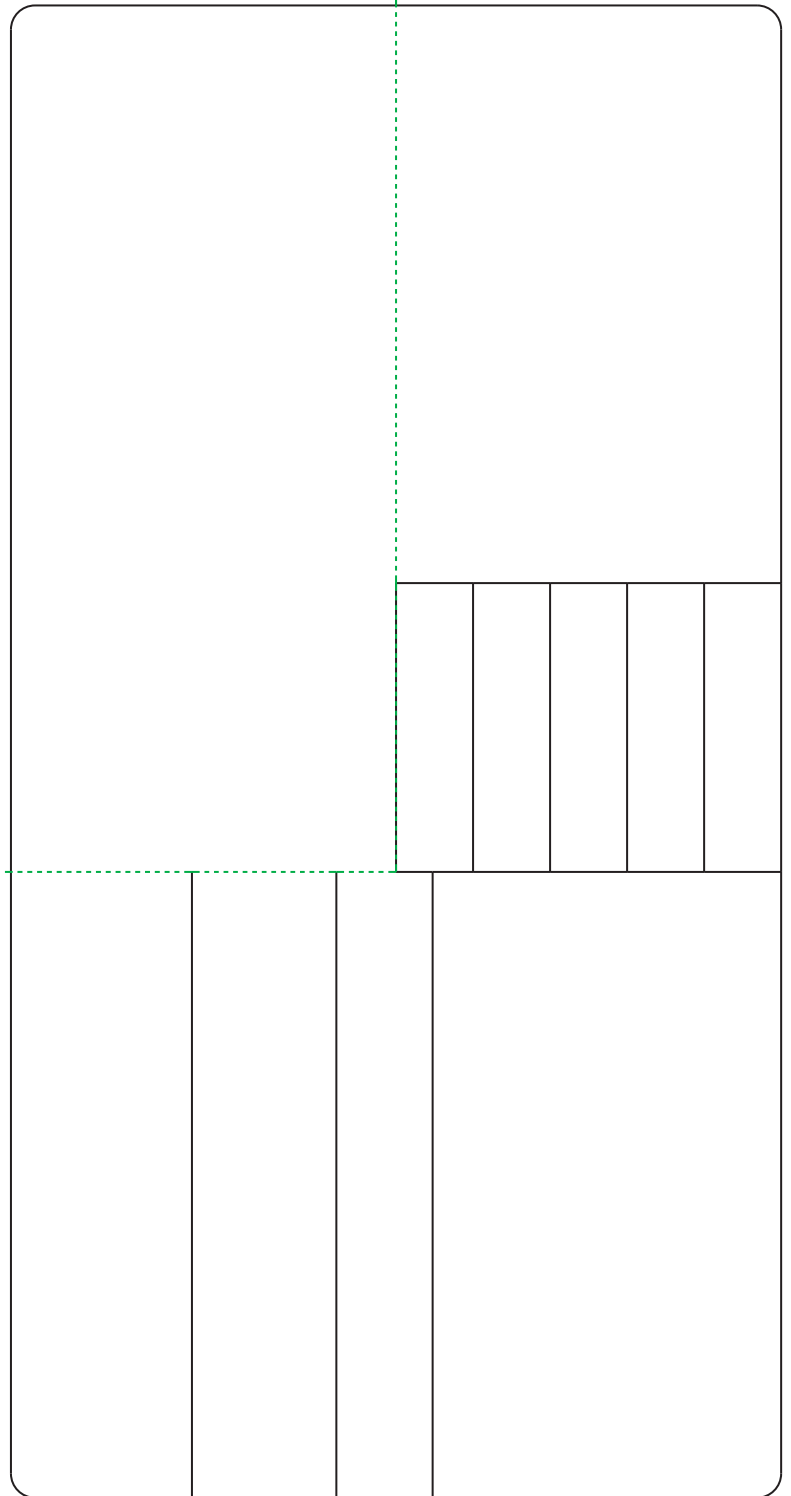

**Labels printed at actual size; see page 89 for details.*

Die #393

Size: 3.75" x 4.25"

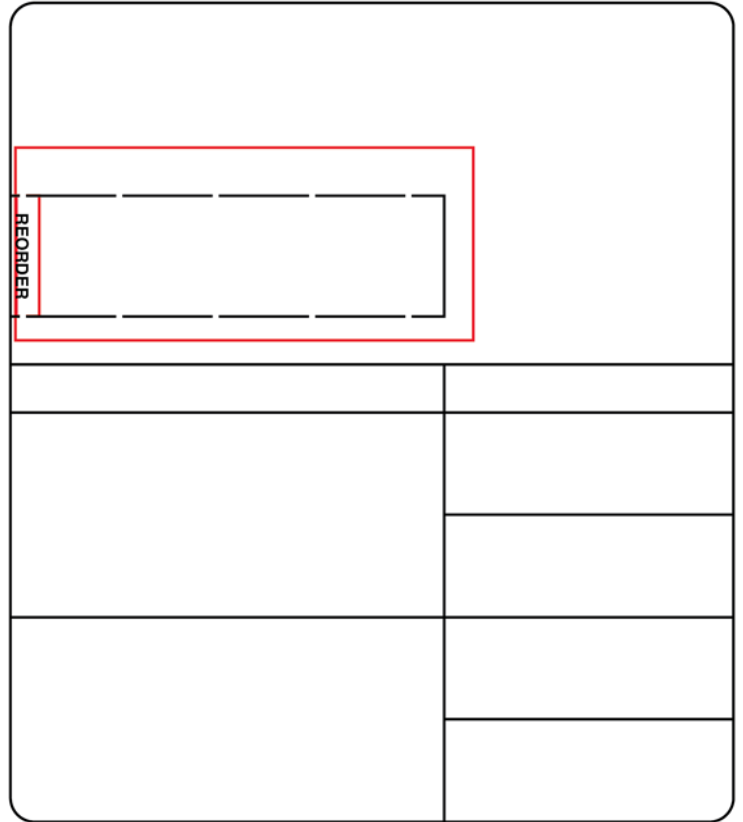

Die #500

Size: 3.688" x 3.875"

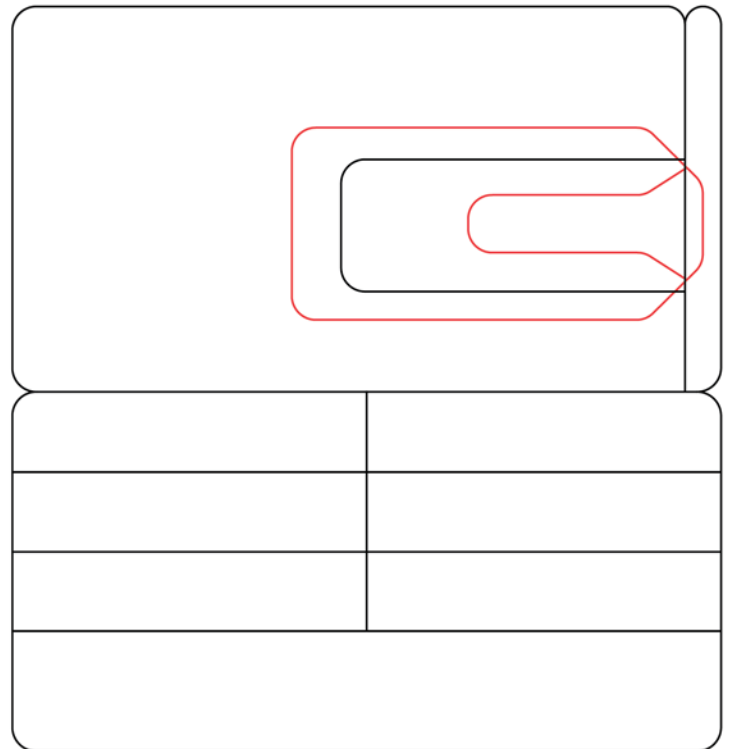

*Labels printed at actual size; see page 89 for details.

Die #453

Size: 4" x 1.835"

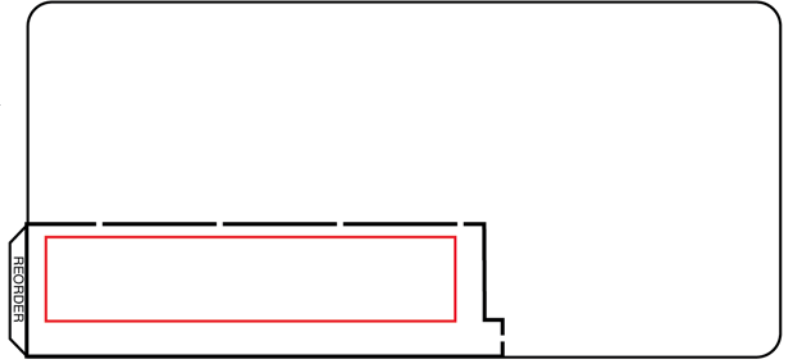

Die #424

Size: 3.688" x 3.625"

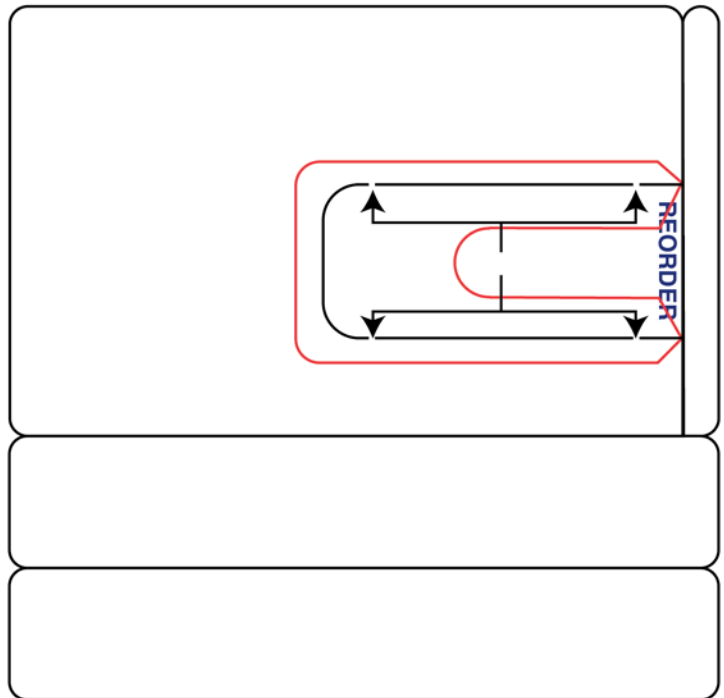

*Labels printed at actual size; see page 89 for details.

Die #350

Size: 3.688" x 2.75"

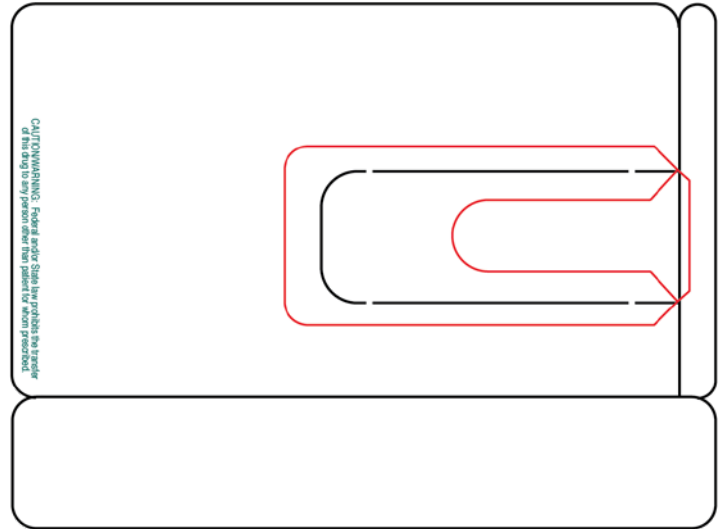

Die #419

Size: 3.313" x 3.875"

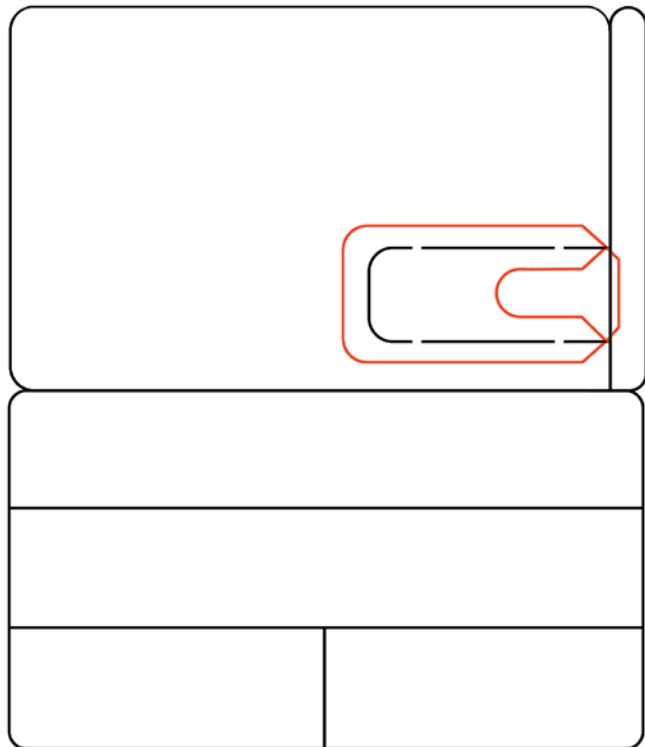

*Labels printed at actual size; see page 89 for details.

Die #541

Size: 3.75" x 3.438"

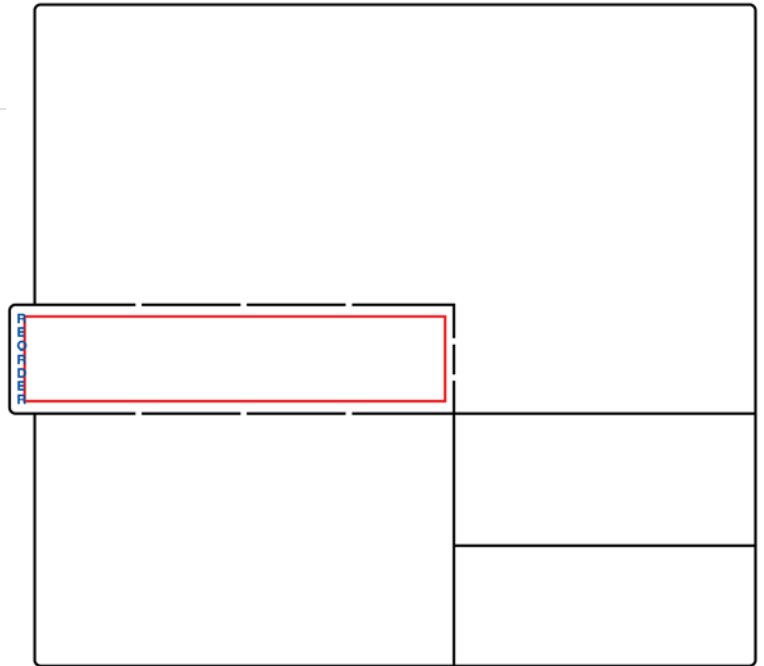

**Labels printed at actual size; see page 89 for details.*

Item L-510-D1

Size: 4" x 1.875"

Quantity: 2,000/Roll; 6 Roll/Box

Material: Direct Thermal

Core: 5"

Ribbon Needed: No



Item L-510-D2

Size: 4" x 2.125"

Quantity: 2,000/Roll; 6 Roll/Box

Material: Direct Thermal

Core: 5"

Ribbon Needed: No



**Labels printed at actual size; see page 89 for details.*

Item L-DS44

Size: 4" x 2"

Quantity: 2,900/Roll; 4 Roll/Box

Material: Thermal Transfer

Core: 3"

Ribbon Needed: Yes



Item L-510-E1

Size: 4" x 2.125"

Quantity: 1,250/Roll; 8 Roll/Box

Material: Direct Thermal Piggyback

Core: 5"

Ribbon Needed: No

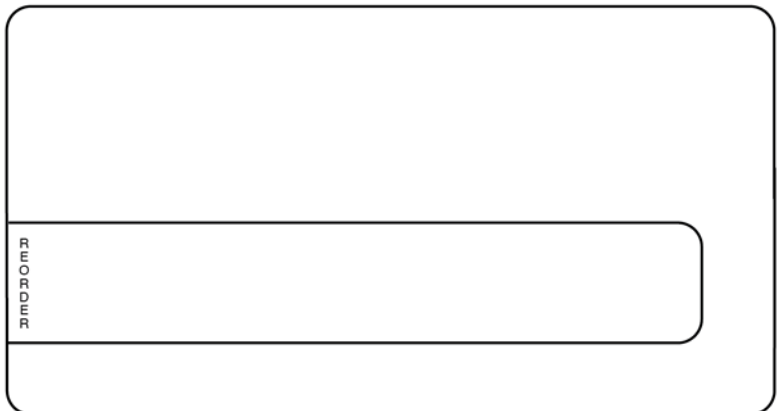

*Labels printed at actual size; see page 89 for details.

DOSIS Labels

Reorder Tab

Quantity: 4,000/Box

Labels

Item Number	Description
L-300-52	4" x 2" with Reorder Tab: No Perforation Between Labels
L-300-53	4" x 2" with Reorder Tab: Perforation Between Labels



DOSIS Labels

No Reorder Tab

Quantity: 4,000/Box

Labels

Item Number	Description
L-300-54	4" x 2" No Reorder Tab: No Perforation Between Labels
L-300-55	4" x 2" No Reorder Tab: Perforation Between Labels



*Labels printed at actual size; see page 89 for details.

DOSIS 4x Time Pass Labels

Reorder Tab

Quantity: 4,000/Box

Labels

Item Number

L-300-56

Description

4" x 2" with Reorder Tab:
No Perforation Between Labels

L-300-57

4" x 2" with Reorder Tab:
Perforation Between Labels

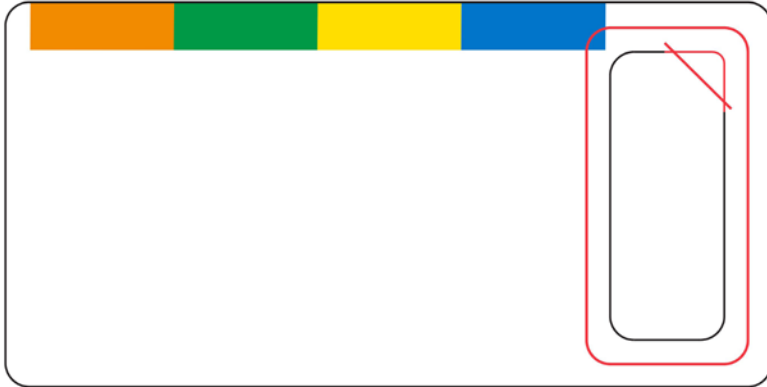

DOSIS 5x Time Pass Labels

Reorder Tab

Quantity: 4,000/Box

Labels

Item Number

L-300-58

Description

4" x 2" with Reorder Tab:
No Perforation Between Labels

L-300-59

4" x 2" with Reorder Tab:
Perforation Between Labels



*Labels printed at actual size; see page 89 for details.

Item L-005A

Quantity: 1,000/Roll

Finish: Roll

AM AM AM

Item L-005AT

Quantity: 1,000/Roll

Finish: Roll

MIDDAY

Item L-005AC

Quantity: 1,000/Roll

Finish: Roll

6:AM

Item L-005AU

Quantity: 1,000/Roll

Finish: Roll

**CHECKED BY
PHARMACIST**

Item L-005AG

Quantity: 1,000/Roll

Finish: Roll

SPECIAL

Item L-005B

Quantity: 1,000/Roll

Finish: Roll

NOON NOON

Item L-005AO

Quantity: 1,000/Roll

Finish: Roll

START HERE

Item L-005C

Quantity: 1,000/Roll

Finish: Roll

PM PM PM

Item L-005AQ

Quantity: 1,000/Roll

Finish: Roll

AS NEEDED

Item L-005CA

Quantity: 1,000/Roll

Finish: Roll

Med. Discontinued on:
Date ___/___/___ Init. ___

*Labels printed at actual size; see page 89 for details.

Item L-005D

Quantity: 1,000/Roll

Finish: Roll



Item L-005I

Quantity: 1,000/Roll

Finish: Roll



Item L-005E

Quantity: 1,000/Roll

Finish: Roll



Item L-005J

Quantity: 1,000/Roll

Finish: Roll



Item L-005F

Quantity: 1,000/Roll

Finish: Roll



Item L-005K

Quantity: 1,000/Roll

Finish: Roll



Item L-005G

Quantity: 1,000/Roll

Finish: Roll



Item L-005L

Quantity: 1,000/Roll

Finish: Roll



Item L-005H

Quantity: 1,000/Roll

Finish: Roll



Item L-005N

Quantity: 1,000/Roll

Finish: Roll



*Labels printed at actual size; see page 89 for details.

Item L-005O

Quantity: 1,000/Roll

Finish: Roll

BALANCE OF ORDER

Item L-005P

Quantity: 1,000/Roll

Finish: Roll

BALANCE TO FOLLOW

Item L-005Q

Quantity: 1,000/Roll

Finish: Roll

HOUSE SUPPLY

Item L-005R

Quantity: 1,000/Roll

Finish: Roll

**DIRECTION
CHANGE
SEE CHART**

Item L-005S

Quantity: 1,000/Roll

Finish: Roll

MORNING

Item L-005T

Quantity: 1,000/Roll

Finish: Roll

AFTERNOON

Item L-005U

Quantity: 1,000/Roll

Finish: Roll

EVENING

Item L-005V

Quantity: 1,000/Roll

Finish: Roll

BEDTIME

*Labels printed at actual size; see page 89 for details.

Item L-019-CDT

Size: 1.875" x 1.375"

Quantity: 4,100/Roll; 12 Roll/Box

Material: Direct Thermal

Core: 3"

Ribbon Needed: No



Item L-503-D1

Size: 1.75" x 1.25"

Quantity: 2,500/Roll; 8 Roll/Box

Material: Direct Thermal

Core: 3"

Ribbon Needed: No



Perforation between labels

Item L-019-C

Size: 1.875" x 1.375"

Quantity: 4,500/Roll; 12 Roll/Box

Material: Thermal Transfer

Core: 3"

Ribbon Needed: Yes

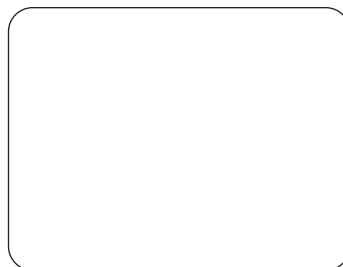

*Labels printed at actual size; see page 89 for details.

Item L-510-D1

Size: 4" x 1.875"

Quantity: 2,000/Roll; 6 Roll/Box

Material: Direct Thermal

Core: 5"

Ribbon Needed: No

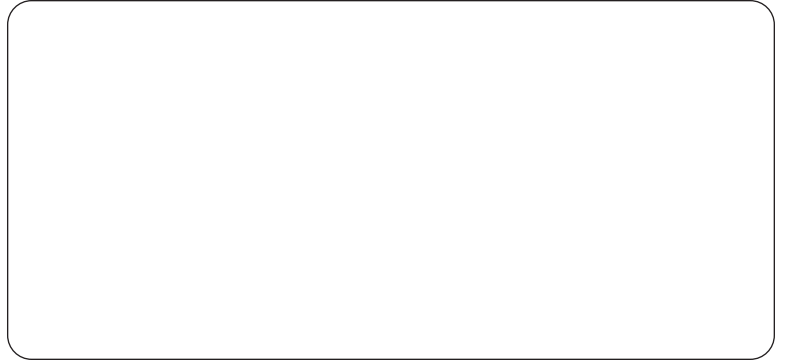

Item L-019-B

Size: 2.75" x 1.938"

Quantity: 3,000/Roll; 10 Roll/Box

Material: Thermal Transfer

Core: 3"

Ribbon Needed: Yes



Item L-DS44

Size: 4" x 2"

Quantity: 2,900/Roll; 4 Roll/Box

Material: Thermal Transfer

Core: 3"

Ribbon Needed: Yes



*Labels printed at actual size; see page 89 for details.

Die #736

Size: 3.25" x 4.5"

Material: Direct Thermal or
Thermal Transfer

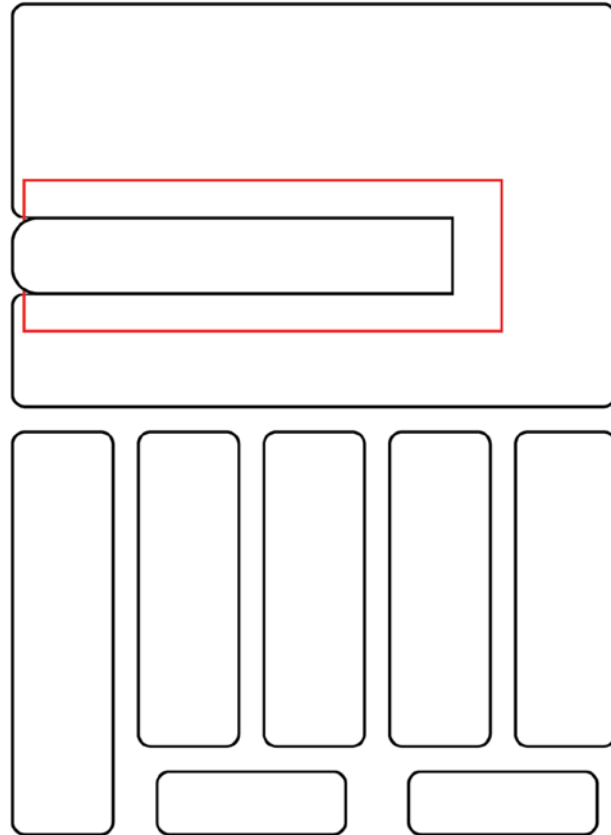

**Labels printed at actual size; see page 89 for details.*

Die #731

Size: 4" x 4.75"

Material: Direct Thermal or
Thermal Transfer

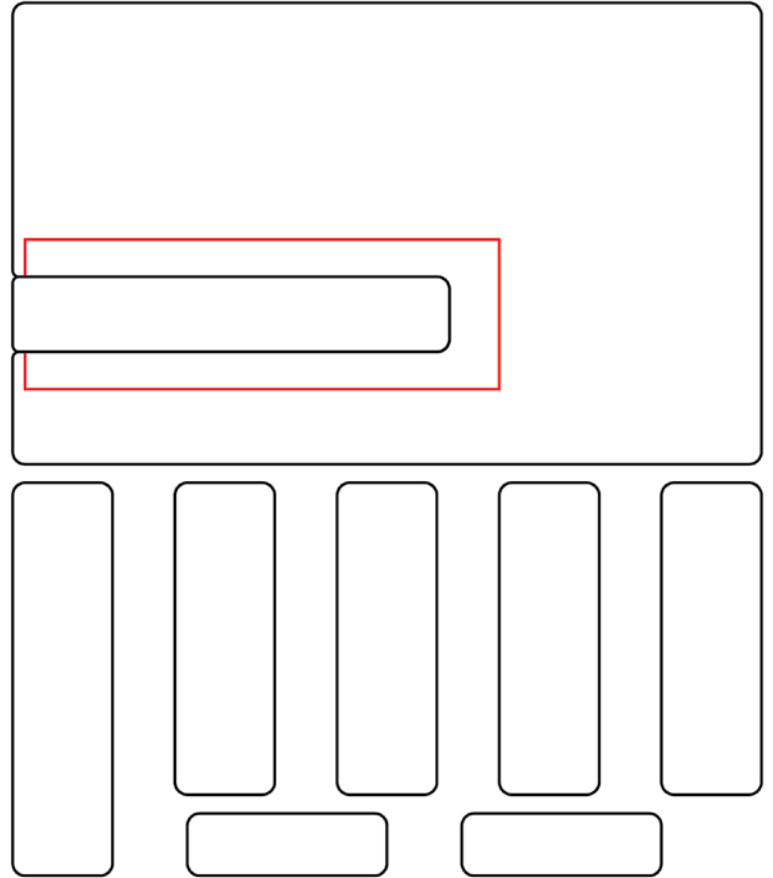

*Labels printed at actual size; see page 89 for details.

Die #650

Size: 4" x 2"

Material: Direct Thermal or Thermal Transfer



Die #651

Size: 4" x 2"

Material: Direct Thermal or Thermal Transfer



Die #350

Size: 3.688" x 2.75"

Material: Direct Thermal or Thermal Transfer

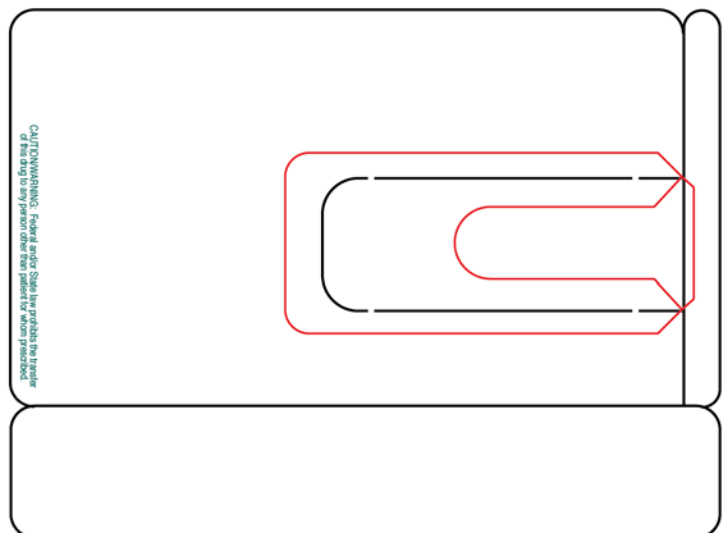

*Labels printed at actual size; see page 89 for details.

Die #555

Size: 3.5" x 5.063"

Material: Direct Thermal or
Thermal Transfer

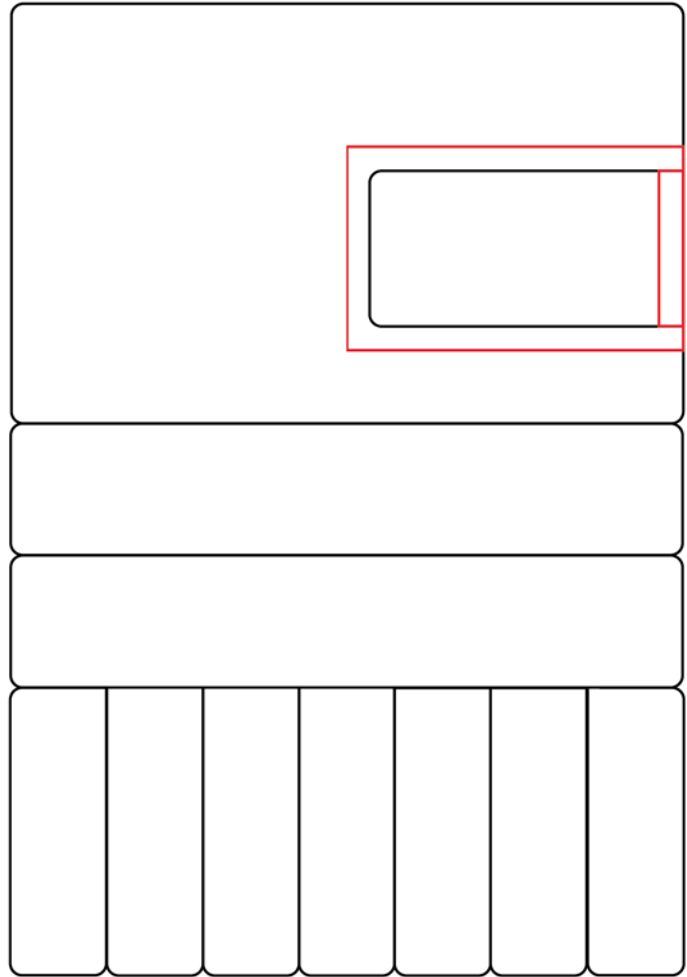

*Labels printed at actual size; see page 89 for details.

Die #556

Size: 3.75" x 5.063"

Material: Direct Thermal or Thermal Transfer

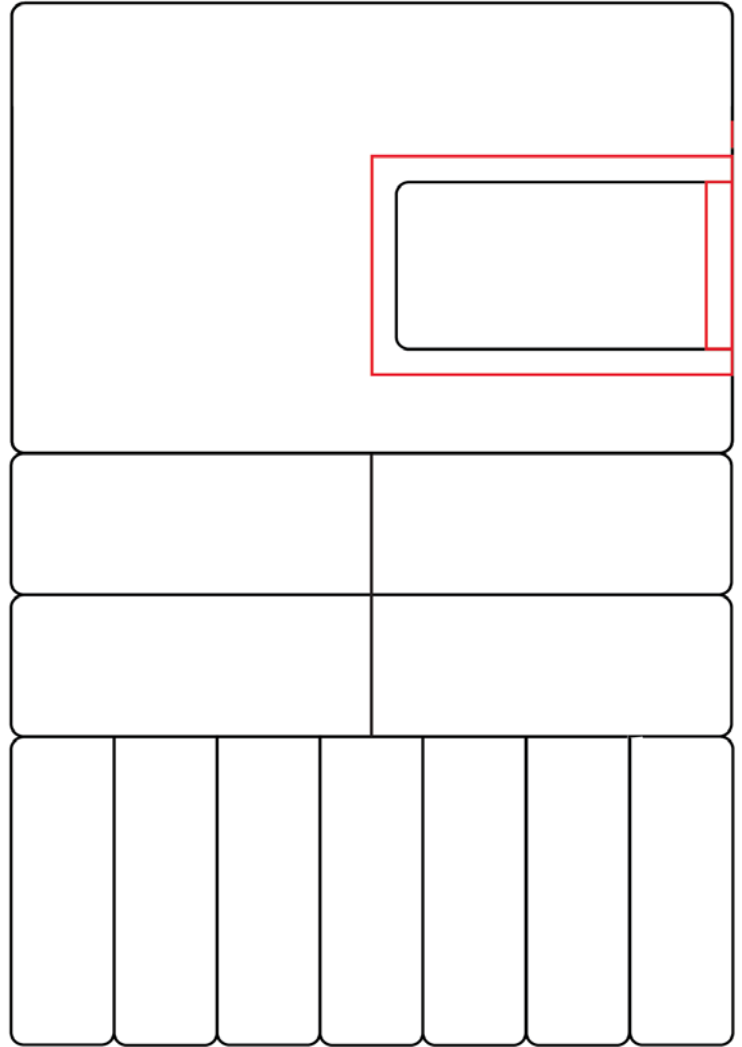

**Labels printed at actual size; see page 89 for details.*

Die #424

Size: 3.688" x 3.625"

Material: Direct Thermal or Thermal Transfer

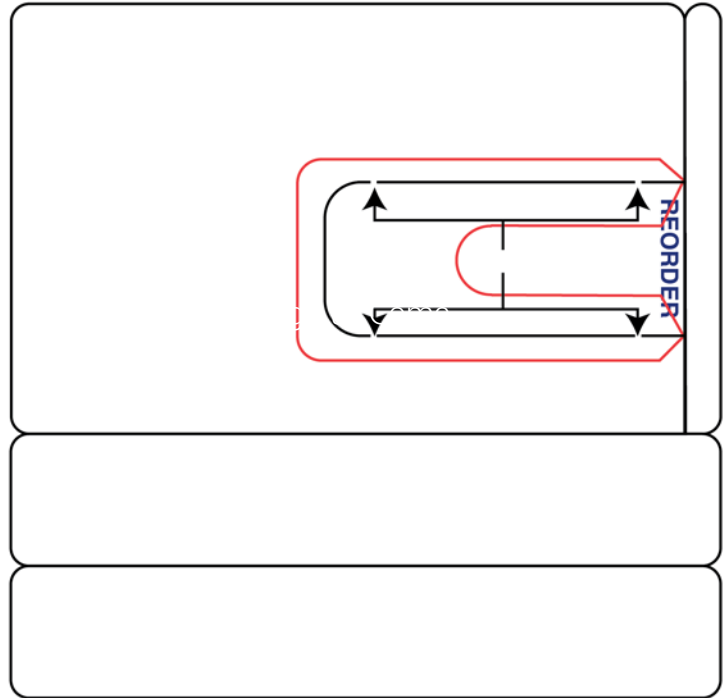

Die #454

Size: 3.688" x 3.625"

Material: Direct Thermal or Thermal Transfer

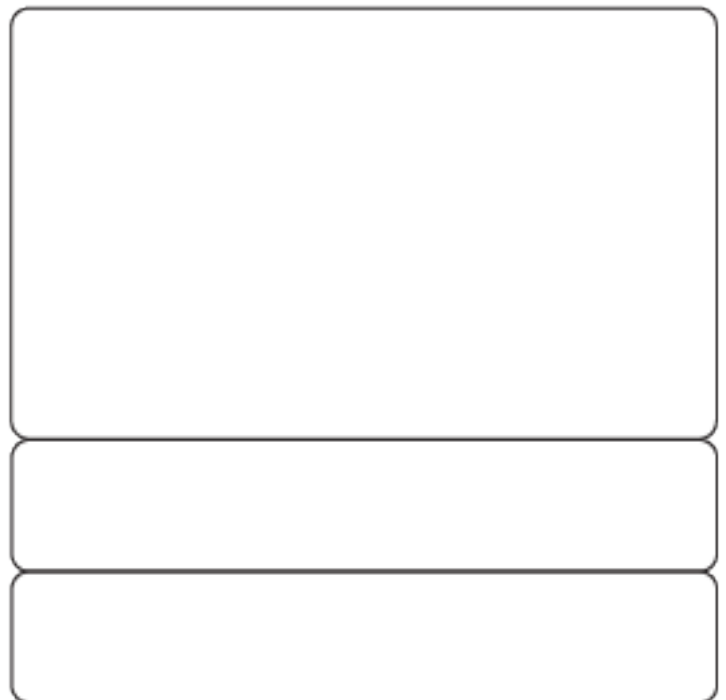

*Labels printed at actual size; see page 89 for details.

Die #471

Size: 3.653" x 2.5"

Material: Direct Thermal or Thermal Transfer

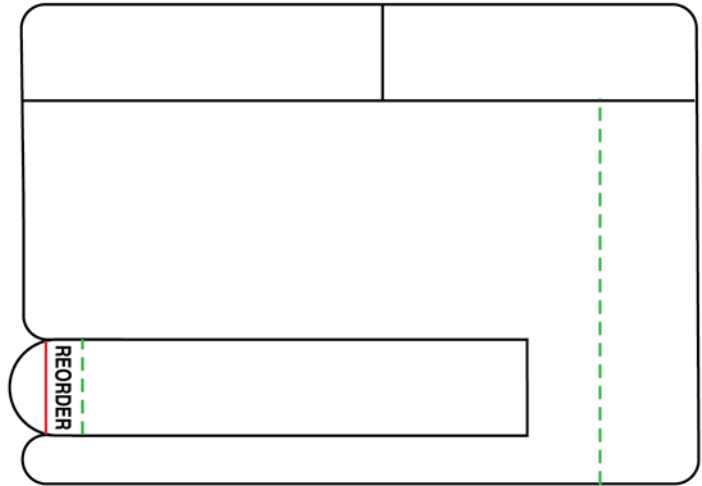

Die #393

Size: 3.75" x 4.25"

Material: Direct Thermal or Thermal Transfer

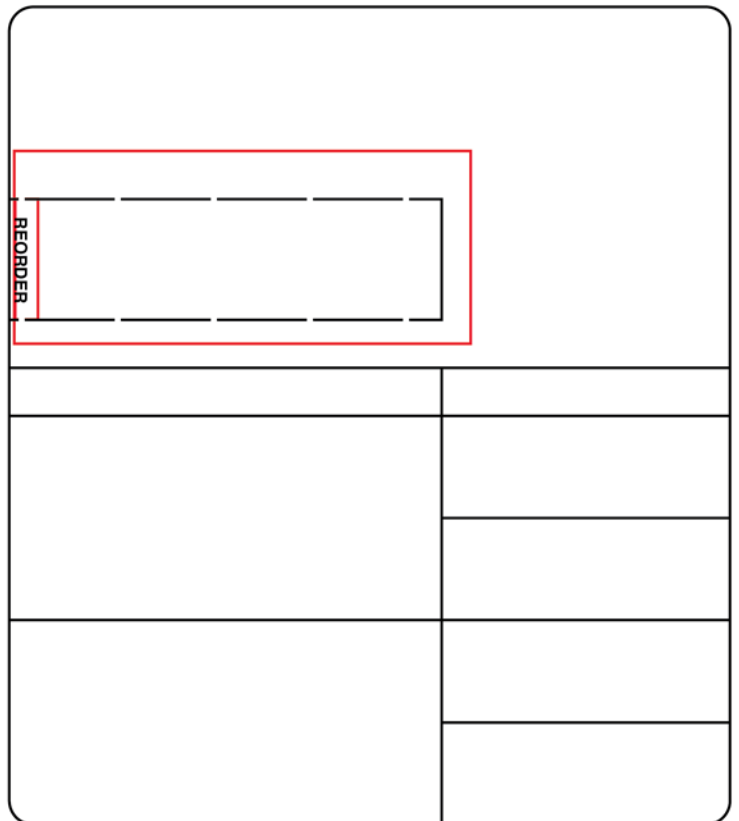

*Labels printed at actual size; see page 89 for details.

Die #594

Size: 4" x 1.875"

Material: Direct Thermal Piggyback

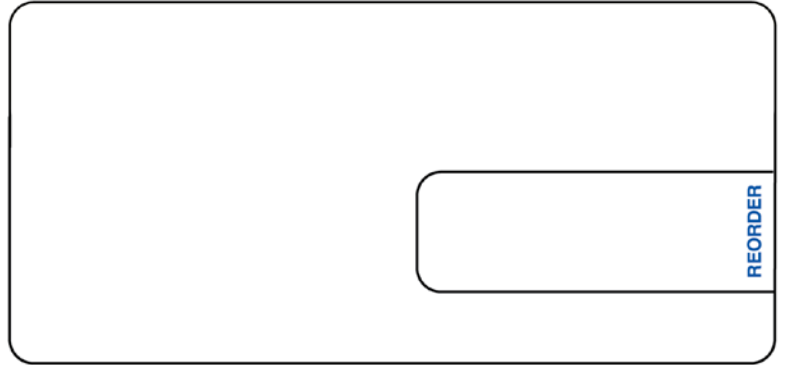

Die #547

Size: 4" x 1.875"

Material: Direct Thermal Piggyback

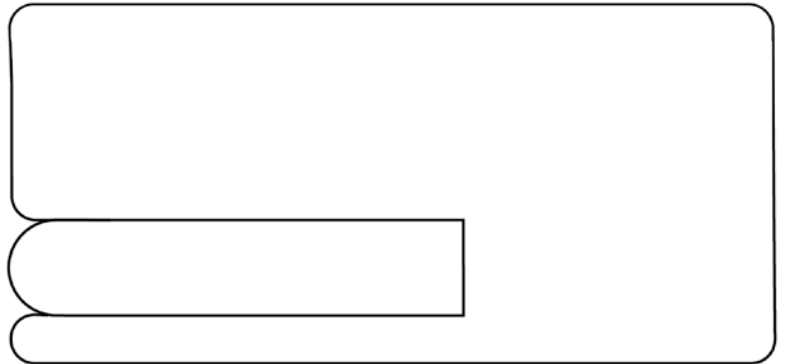

*Labels printed at actual size; see page 89 for details.

Die #694

Size: 4" x 2.125"

Material: Direct Thermal Piggyback

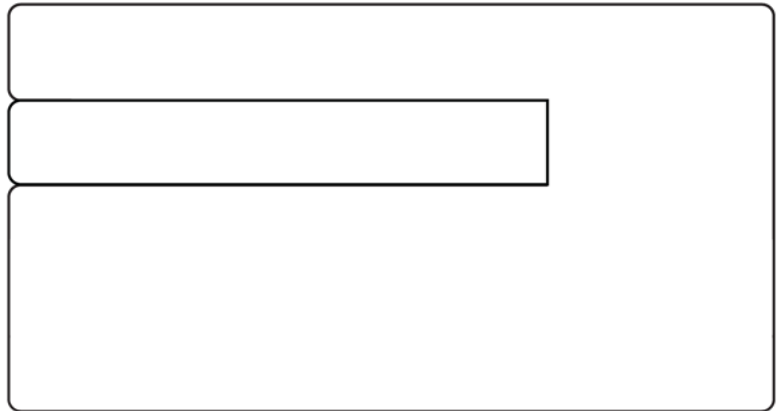

Die #630

Size: 4" x 2.125"

Material: Direct Thermal Piggyback

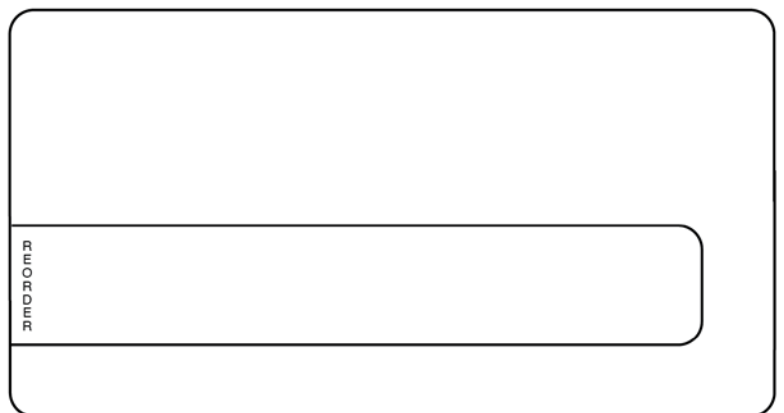

**Labels printed at actual size; see page 89 for details.*

Ribbon

Omnicell quality does not stop at labels, we have a premier selection of ribbon to support your pharmacy's needs.

Omnicell Ribbons work with the following printers:

- Datamax
- Cognative
- Eltron
- Intermec
- Zebra
- Sato
- Printronix
- RJS
- Tharo
- Cab Squix
- And Many Others!



Item Number	Description	Size	Coated Side In (CSI)/ Coated Side Out (CSO)	Quantity
TTR-006*	Thermal Transfer Ribbon	6.14" x 984'	CSO	12 Roll/Box
TTR-008*	Thermal Transfer Ribbon	2.52" x 1345'	CSI	36 Roll/Box
TTR-001	Thermal Transfer Ribbon	3" x 1345'	CSI	24 Roll/Box
TTR-003	Thermal Transfer Ribbon	2.125" x 1345'	CSI	36 Roll/Box
TTR-007	Thermal Transfer Ribbon	6" x 1476'	CSI	12 Roll/Box
TTR-010	Thermal Transfer Ribbon	3.27" x 1181'	CSI	24 Roll/Box
TTR-011	Thermal Transfer Ribbon- Full Resin	6.5" x 1181'	CSI	12 Roll/Box
TTR-017	Thermal Transfer Ribbon	10.75" x 984'	CSI	6 Roll/Box
TTR-054	Thermal Transfer Ribbon	2" x 1181'	CSI	36 Roll/Box
TTR-056	Thermal Transfer Ribbon	6" x 1181'	CSI	12 Roll/Box
TTR-058	Thermal Transfer Ribbon	4.17" x 1476'	CSI	24 Roll/Box
TTR-002	Thermal Transfer Ribbon	3.15" x 984'	CSO	36 Roll/Box
TTR-004	Thermal Transfer Ribbon	4.17" x 1476'	CSO	24 Roll/Box
TTR-009	Thermal Transfer Ribbon	7" x 1476'	CSO	12 Roll/Box
TTR-025	Thermal Transfer Ribbon	4" x 1476'	CSO	24 Roll/Box
TTR-028	Thermal Transfer Ribbon- Full Resin	3.15" x 1476'	CSO	24 Roll/Box
TTR-057	Thermal Transfer Ribbon	2.52" x 1476'	CSO	36 Roll/Box
TTR-026	Thermal Transfer Ribbon- Full Resin	4" x 243'	CSO	36 Roll/Box
TTR-027	Thermal Transfer Ribbon- Full Resin	6" x 984'	CSO	12 Roll/Box
TTR-040	Thermal Transfer Ribbon	4.33" x 243'	CSO	24 Roll/Box
TTR-043	Thermal Transfer Ribbon- Full Resin	4.33" x 1476'	CSO	24 Roll/Box
TTR-050	Thermal Transfer Ribbon	4.33" x 243'	CSO	36 Roll/Box
TTR-052	Thermal Transfer Ribbon	2.36" x 984'	CSO	36 Roll/Box

*Used with Unit Dose Foil Printer on page 123

Item 680-11

Thermal Transfer Foil with Pin Feed

Quantity: 1000 Sheets/Roll; 4 Rolls/Box

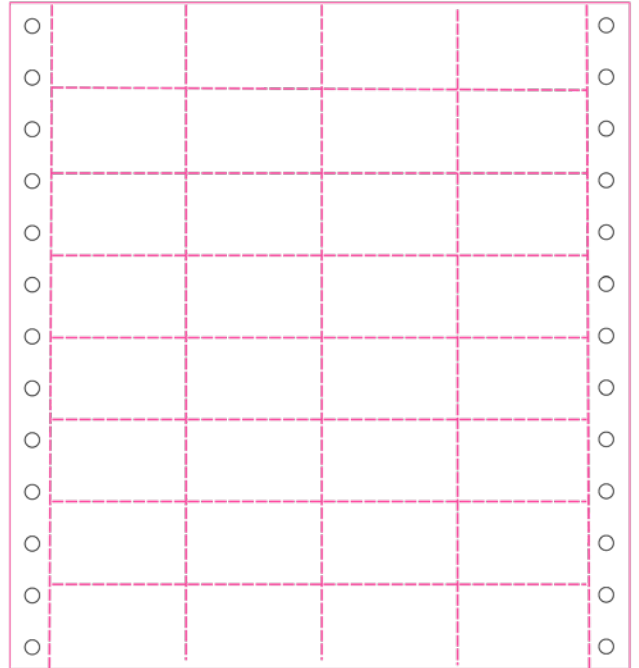

Item 680-12

Thermal Transfer Foil

Quantity: 2000 Sheets/Roll; 12 Rolls/Box



Item 680-19

Thermal Transfer Foil: 1-Step Select Seal
E2/E3 Compatible

Quantity: 1000 Sheets/Roll; 4 Rolls/Box

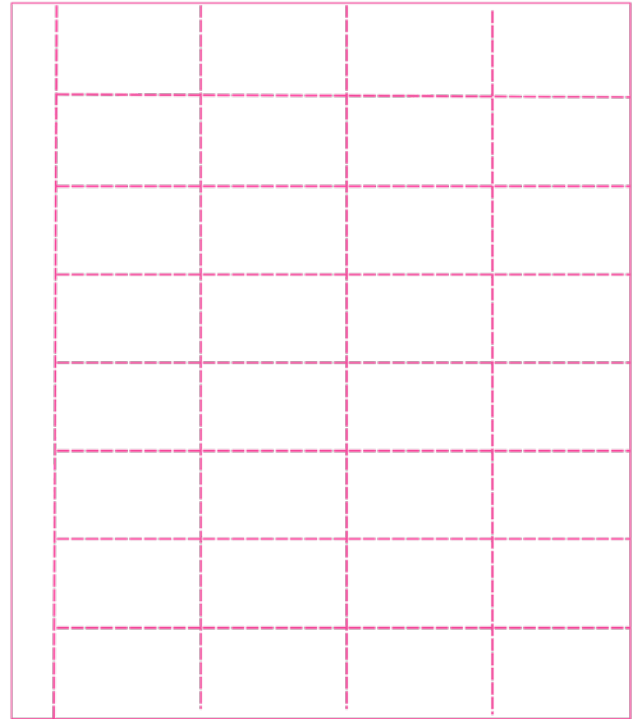

Item 680-19-3

Thermal Transfer Foil: 1-Step Select Seal
E2/E3 Compatible

Quantity: 2500 Sheets/Roll; 4 Rolls/Box

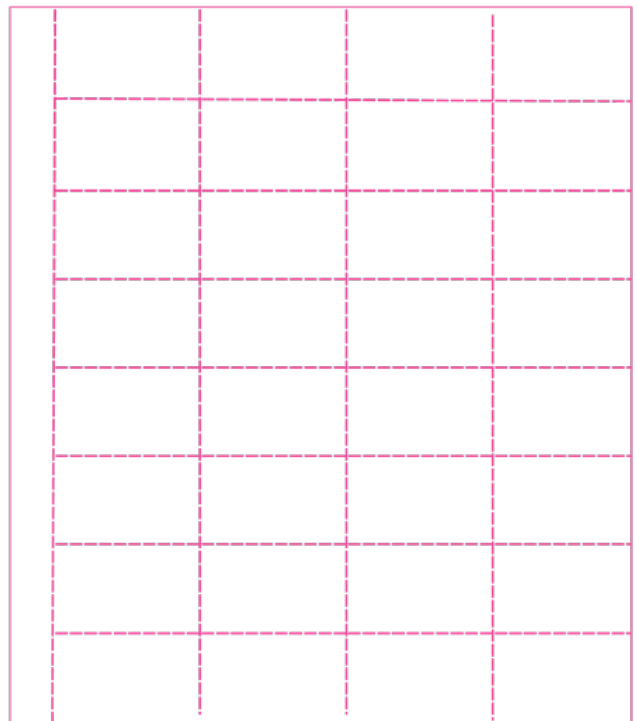

Item 680-22

Thermal Transfer Foil

Quantity: 1000 Sheets/Roll; 12 Rolls/Box

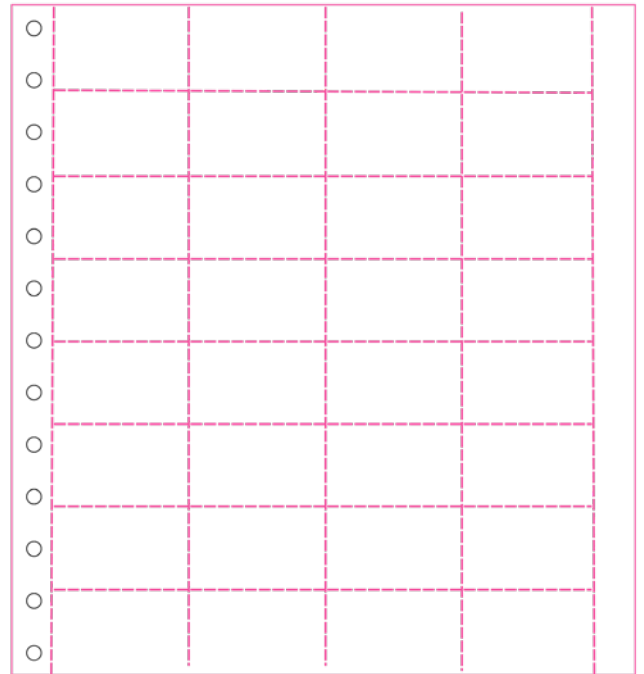

Unit Dose Foil Labeling System

Omniceil's unit dose foil labeling system meets the unique needs of the long term care pharmacy by producing high quality bar code scannable label sheets quickly and efficiently. This standalone system prints foil lidding containing all pertinent drug information and barcodes.

- Accommodate diverse packaging needs including unit-dose box, short-cycle dispensing, reclaimable blister cards, eKits and automated dispensing cabinets
- Reduce waste by pre-packing expensive medications into reclaimable blister cards (as allowed by state regulations)
- Track log numbers and expiration dates using barcode technology, with option of printable daily production report

Included

- Tharo H627 – 203 dpi thermal transfer printer
- Rotary cutter
- Labeling software program with database and report generator
- Barcode scanner with cable and stand
- Communication cables

Usage

This high-speed durable printer prints up to 18 sheets of Omnicell foil (576 unit doses) per minute. The printer automatically cuts the foil to size, making it ready for direct application to the unit dose blister. The Unit Dose Foil Labeling System can be used standalone or in conjunction with Omnicell automation.



Unit Dose with printed barcode



Tharo H627 thermal transfer printer

Reach out to your Omnicell Sales Representative for more information.

Kyocera EcoSys P8060CDN

Required for SureMedXL (309-96GLB)



Epson EP-C7000

Used for SureMed Standard (300-96), SureMed Plus (301-96),
SureMed 30 (302-96)



Desktop Label Applicator (DLA)

Omniceil's Desktop Label Applicator System automates the labeling process for pre-pack operations, reducing labor time and increasing efficiency. The high-speed applicator system applies labels immediately after packing, ensuring perfect placement every time. With options for semi-automatic and fully automatic systems, we offer solutions to meet your pharmacy needs.

Solution Benefits

- The perfect complement to Omnicell's MTS-350 to complete your pre-packing operations
- Color touch screen interface
- Standard low ribbon and low label sensing
- On-screen troubleshooting and diagnostic tools
- Realtime running statistics including batch/shift counts, parts per minute statistics and machine life counts
- Course and fine adjustments to accommodate various label placements



DLA200 – Fully-Automatic

Site Requirements

Dimensions

Approximately 33"W x 24"D x 37"H

Weight: Approximately 180 lbs

Label Roll Diameter: 3" ID and Up to 12" OD

Air Requirements

Compressed Air: Clean, Dry, 80 PSI, 5 CFM

Electrical Requirements

115Vac, 5 Amps, 60Hz Single Phase

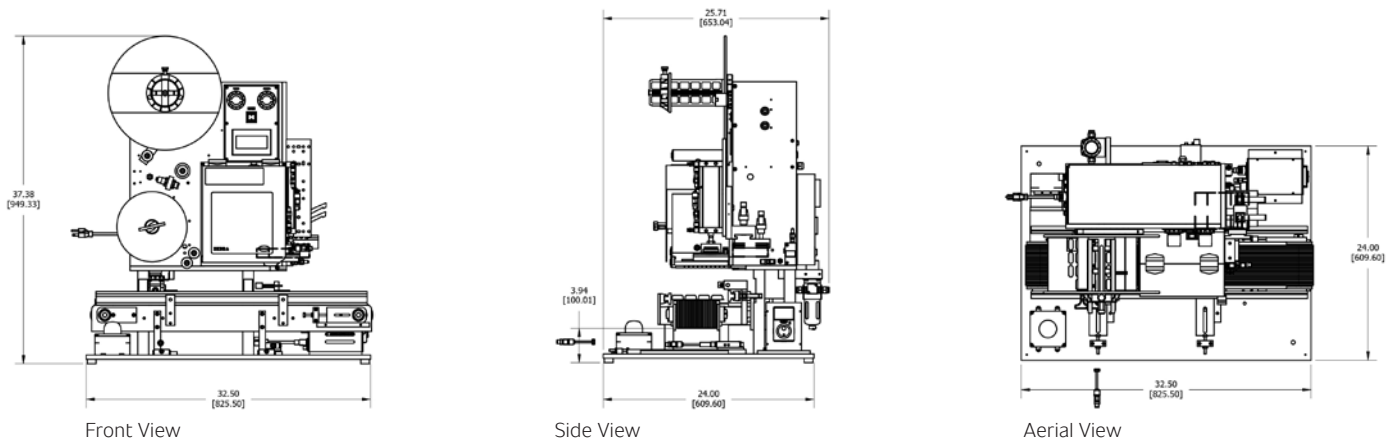

Miscellaneous Accessories



Omnicell has procured a variety of helpful tools and complementary accessories to support your pharmacy's medication adherence services.

Roller

Item 660-00

Cold Seal Roller

Quantity: 1



Pil-Bob

Item 660-10

Pil-Bob Blister Opener and Pill Remover

Quantity: 25/Box



Unit Dose Boxes

Item UD-250

Unit Dose Box: 5" x 1-5/8" x 2-1/4"

Quantity: 1000/Box



Item UD-251

Unit Dose Box: 4-11/16" x 1-9/16" x 2-3/8"

Quantity: 1000/Box



Item UD-286

Reorder Alert Card

Quantity: 1000/Box

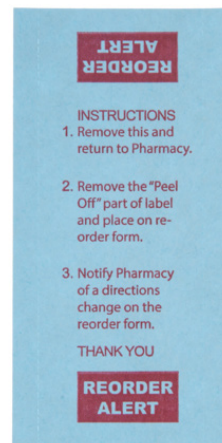

Storage Bin Boxes

Item UD-612

Storage Bin Box: 18"D x 6-1/4"W x 8"H

Quantity: 25/Box



Item UD-613

Storage Bin Box: 12"D x 6-1/4"W x 8"H

Quantity: 25/Box



Item A-9399

E2/E3 Automation Stacker Box

Quantity: 25/Box



Placebo Pills

Item TP-GC202210

Placebo, Capsule Size 4

Quantity: 1000/Bottle



Item TP-GCC101022

Placebo, Capsule Size 0

Quantity: 1000/Bottle



Placebo Pills

Item TPCB-101016

Placebo, Round Blue

Quantity: 1000/Bottle



Item TPCR-101015

Placebo, Round Red

Quantity: 1000/Bottle



Item TPCY-101014

Placebo, Round Yellow

Quantity: 1000/Bottle



Placebo Pills

Item TPUW-101017

Placebo, Round White (0.4375")

Quantity: 1000/Bottle



Item TPUW-101019

Placebo, Caplet Standard

Quantity: 1000/Bottle



Item TPUW-101030

Placebo, Pellet/Slug

Quantity: 1000/Bottle



Custom Product



Omniceil offers a wide range of customizable blister cards and labeling solutions. Whether you're looking to reinforce brand recognition, meet specific regulatory requirements, or enhance patient engagement, our customization options are designed to support your goals.

Custom Cards

Omniceil offers pharmacies the ability to personalize our standard heat seal and cold seal blister cards with custom artwork, logos, and color schemes – creating a professional, branded experience that reflects your pharmacy's identity.

- **Minimum Order:** 25,000 units
- **Turnaround Time:** 28 business day lead time plus shipping once PO is received

For more information or to begin a custom card project, please contact MAInsideSales@Omniceil.com

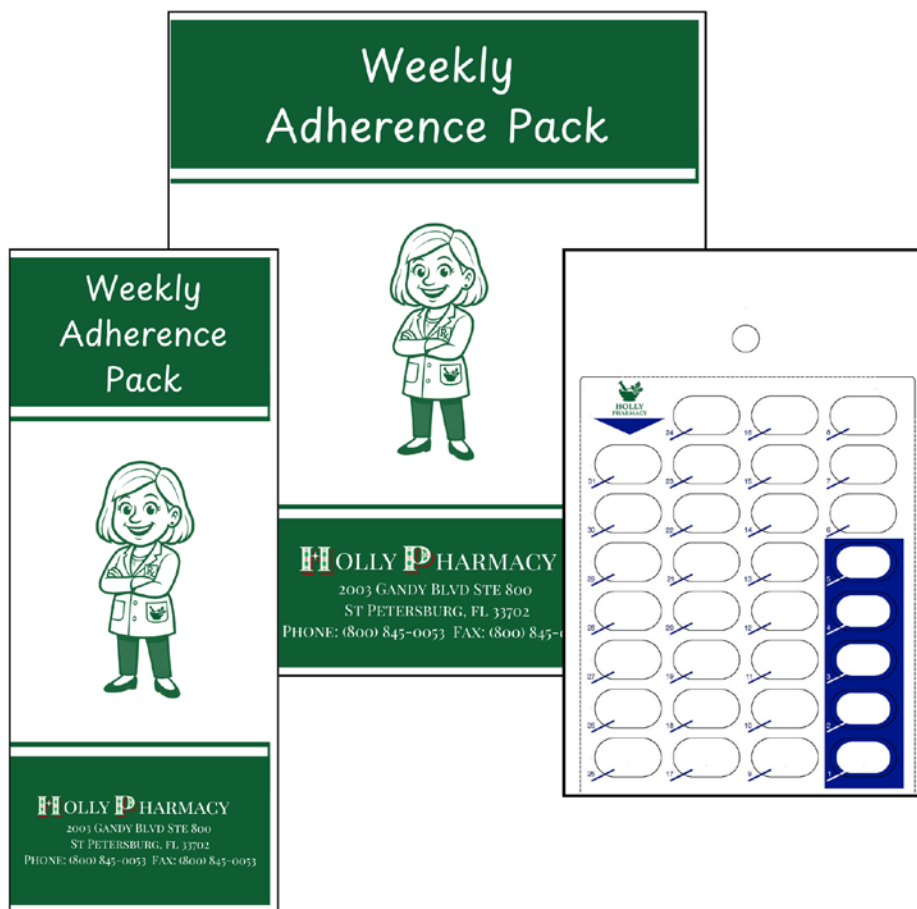

Minimum order quantities and lead times apply for custom orders. Our team is available to guide you through the design and ordering process.

Custom Labels

Omniceil's custom label offerings are designed to enhance pharmacy operations, support automation, and reinforce your brand identity. Our in-house graphics department works closely with pharmacies to develop label designs tailored to specific branding and operational needs.

Available for Customization

- Software Specific Labels
- Pre-pack Labels
- Direct Thermal
- Thermal Transfer
- Auxiliary and Time Pass Labels
- **Minimum Order:** 50,000 units
- **Turnaround Time:** 28 business day lead time plus shipping once PO is received

For more information or to begin a custom label quote, please send a clear photo of your label via email to CustomerService@Omniceil.com.

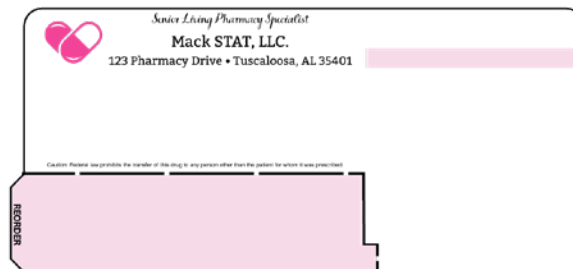
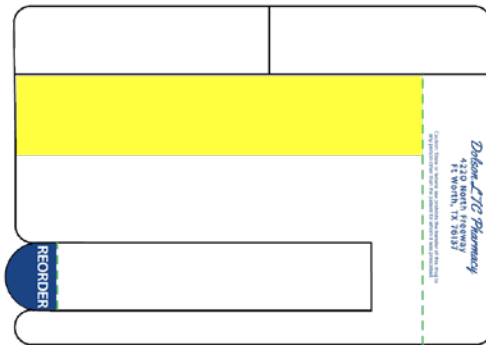
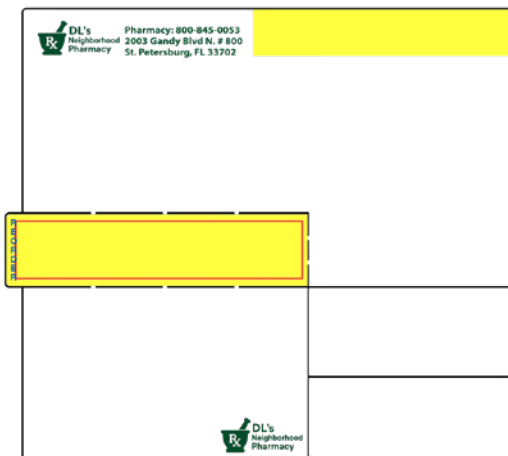

Minimum order quantities and lead times apply for custom orders. Our team is available to guide you through the design and ordering process.

